



SQUARE GRATE/COVER REPLACEMENTS

Notes:

1. Casting number indicates a part number & is generally located on the underside of each cleanout cover.
2. Order number used for all ordering purposes.
3. Standard Cover Material is Cast Iron. Order numbers may vary for different materials.
4. Contact your local sales representative for all order inquiries & assistance on material availability as these may vary from part to part.

FLOOR DRAINS

Z400S, Z415S							
Item No.	Strainer Designation	Dimensions in inches [mm]			Open Area. Sq. In.	Ordering No.	Casting No.
		Length	Width	Thickness			
1	5S	4-5/8 [117]	4-5/8 [117]	1/8 [3]	9	PN400-5S-GRID	46467-1
2	6S	5-5/8 [143]	5-5/8 [143]	1/8 [3]	13	PN400-6S-GRID	46469-1
3	7S	6-11/16 [170]	6-11/16 [170]	1/8 [3]	21	PN400-7S-GRID	46777-1
4	8S	7-11/16 [195]	7-11/16 [195]	1/8 [3]	28	PN400-8S-GRID	46470-1
5	10S	7-11/16 [195]	7-11/16 [195]	1/8 [3]	28	PN400-10S-GRID	46470-1

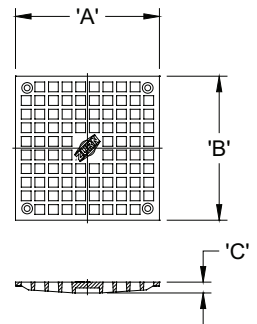

Z400J, Z415J							
Item No.	Strainer Designation	Dimensions in inches [mm]			Open Area. Sq. In.	Ordering No.	Casting No.
		Length	Width	Thickness			
6	8J	7-7/16 [189]	3-15/16 [100]	1/8 [3]	12	PB400-8J-STR-USA	2850-1
7	9J	7 [178]	3-1/2 [89]	3/16 [5]	15	PN400-9J-STR	50155-1
8	13J	11-11/16 [297]	4-13/16 [122]	3/16 [5]	20	PN400-13J-GRATE-USA	33108-1
9	17J	15-25/32 [401]	3-13/16 [97]	7/32 [6]	29	PN400-17J-STR-USA	45207-1
10	21J	20-1/16 [510]	4-1/16 [103]	1/4 [6]	32	PB400-21J-STR-USA	50288-1
11	20J "2 Piece"	9-7/8 [251]	9-1/16 [230]	1/4 [6]	66	PN400-20J-GRATE1-USA	29042-1

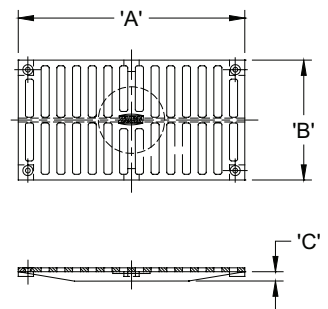

Z400SH, Z415SH							
Item No.	Strainer Designation	Dimensions in inches [mm]			Open Area. Sq. In.	Ordering No.	Casting No.
		Length	Width	Thickness			
12	6SH	5-3/8 [137]	4-15/32 [114]	3/32 [2]	12	PN400-6SH-STR-USA	28899-1
13	8SH	7-11/16 [195]	5-1/2 [140]	1/8 [3]	21	PN400-8SH-STR-USA	36689-1

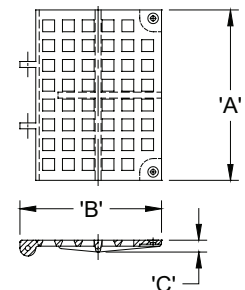

⚠ WARNING: Cancer and Reproductive Harm - www.P65Warnings.ca.gov
⚠ ADVERTENCIA: Cáncer y daño reproductivo - www.P65Warnings.ca.gov
⚠ AVERTISSEMENT: Cancer et effets néfastes sur la reproduction - www.P65Warnings.ca.gov

Zurn Industries, LLC | Specification Drainage Operation
1801 Pittsburgh Avenue, Erie, PA 16502, Ph. 855.663.9876

In Canada | Zurn Industries Limited
7900 Goreway Drive, Unit 10, Brampton, Ontario L6T 5W6, Ph. 877.892.5216

www.zurn.com

Rev. -
 Date: 12/06/23
 C.N. No. 145578
 Prod. | Dwg. No. FD138



SQUARE GRATE/COVER REPLACEMENTS

Z400SZ, Z415SZ, Z461							
Item No.	Strainer Designation	Dimensions in inches [mm]			Open Area. Sq. In.	Ordering No.	Casting No.
		Length	Width	Thickness			
14	5SZ	4-5/8 [117]	4-5/8 [117]	1/8 [3]	8	PB400-5SZ-STRAINER	306465-1
15	6SZ	5-5/8 [143]	5-5/8 [143]	1/8 [3]	13	PB400-6SZ-STRAINER	306468-1

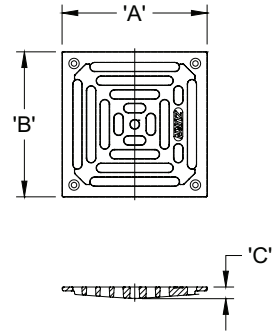

Z629							
Item No.	Strainer Designation	Dimensions in inches [mm]			Open Area. Sq. In.	Ordering No.	Casting No.
		Length	Width	Thickness			
16	3, 4	8-9/16 [217]	6-3/16 [157]	5/16 [8]	20	P629-GRATE-3-4-USA	4179-1
17	6	10-5/16 [262]	7-13/16 [198]	3/8 [10]	33	P629-GRATE-6-USA	4649-1

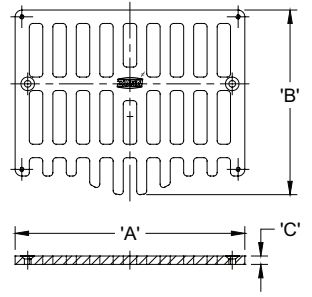

Z400SS, Z415SS, Z1727							
Item No.	Strainer Designation	Dimensions in inches [mm]			Open Area. Sq. In.	Ordering No.	Casting No.
		Length	Width	Thickness			
18	5SS	4 5/8	4 5/8	1/8	9	PS400-S-SQ5-STR	66735-1
19	6SS	5 5/8	5 5/8	1/8	13	PS400-S-SQ6-STR	66736-1
20	8SS	7 11/16	7 11/16	1/8	25	667370015	66737-1

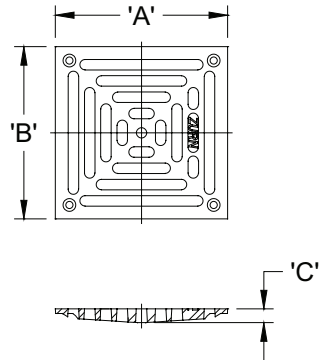

⚠ **WARNING:** Cancer and Reproductive Harm - www.P65Warnings.ca.gov
 ⚠ **ADVERTENCIA:** Cáncer y daño reproductivo - www.P65Warnings.ca.gov
 ⚠ **AVERTISSEMENT:** Cancer et effets néfastes sur la reproduction - www.P65Warnings.ca.gov

Zurn Industries, LLC | Specification Drainage Operation
 1801 Pittsburgh Avenue, Erie, PA 16502, Ph. 855.663.9876

In Canada | Zurn Industries Limited
 7900 Goreway Drive, Unit 10, Brampton, Ontario L6T 5W6, Ph. 877.892.5216

www.zurn.com

Rev. -
 Date: 12/06/23
 C.N. No. 145578
 Prod. | Dwg. No. FD138



SQUARE GRATE/COVER REPLACEMENTS

Z150						
Item No.	Dimensions in inches [mm]			Open Area. Sq. In.	Ordering No.	Casting No.
	Length	Width	Thickness			
21	12-13/16 [325]	12-13/16 [325]	5/16 [8]	44	P150-GRATE-USA	52095-1

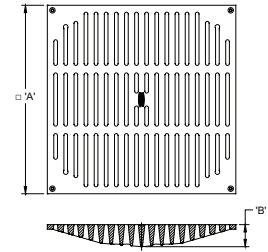

Z150-DT						
Item No.	Dimensions in inches [mm]			Open Area. Sq. In.	Ordering No.	Casting No.
	Length	Width	Thickness			
22	12-13/16 [325]	12-13/16 [325]	5/16 [8]	56	P150-GRATE-DT	82342-1

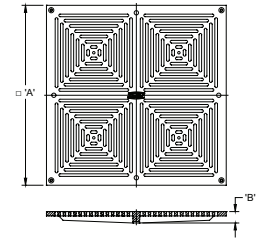

Z154						
Item No.	Dimensions in inches [mm]			Open Area. Sq. In.	Ordering No.	Casting No.
	Length	Width	Thickness			
23	10-7/8 [276]	10-7/8 [276]	5/16 [8]	34	P154-GRATE-USA-NS	67578-1

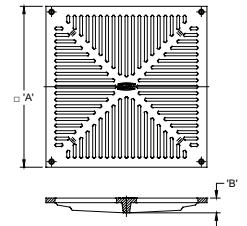

Z158						
Item No.	Dimensions in inches [mm]			Open Area. Sq. In.	Ordering No.	Casting No.
	Length	Width	Thickness			
24	8-7/8 [225]	8-7/8 [225]	1/4 [6]	21	P158-GRATE	67671-1

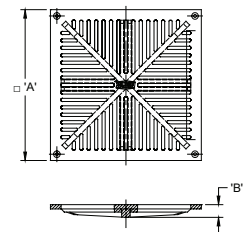

Z400SC						
Item No.	Dimensions in inches [mm]			Open Area. Sq. In.	Ordering No.	Casting No.
	Length	Width	Thickness			
25	5-11/16 [144]	5-11/16 [144]	1/4 [6]	0	832450012	83245-1

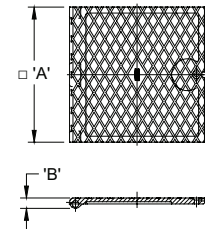

⚠ **WARNING:** Cancer and Reproductive Harm - www.P65Warnings.ca.gov
 ⚠ **ADVERTENCIA:** Cáncer y daño reproductivo - www.P65Warnings.ca.gov
 ⚠ **AVERTISSEMENT:** Cancer et effets néfastes sur la reproduction - www.P65Warnings.ca.gov

Zurn Industries, LLC | Specification Drainage Operation
 1801 Pittsburgh Avenue, Erie, PA 16502, Ph. 855.663.9876

In Canada | Zurn Industries Limited
 7900 Goreway Drive, Unit 10, Brampton, Ontario L6T 5W6, Ph. 877.892.5216

www.zurn.com

Rev. -
 Date: 12/06/23
 C.N. No. 145578
 Prod. | Dwg. No. FD138



SQUARE GRATE/COVER REPLACEMENTS

Z513						
Item No.	Dimensions in inches [mm]			Open Area. Sq. In.	Ordering No.	Casting No.
	Length	Width	Thickness			
26	8-5/16 [211]	8-5/16 [211]	5/8 [16]	20	P513-GRATE	56653-8

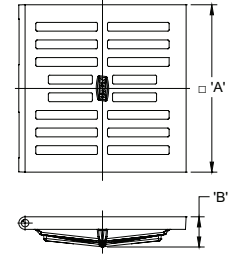

Z535						
Item No.	Dimensions in inches [mm]			Open Area. Sq. In.	Ordering No.	Casting No.
	Length	Width	Thickness			
27	11-1/4 [286]	11-3/8 [289]	11/16 [17]	52	P535-GRATE	57139-1

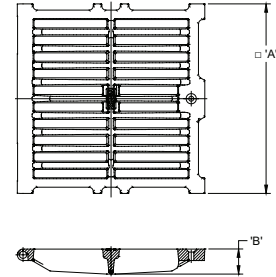

Z537						
Item No.	Dimensions in inches [mm]			Open Area. Sq. In.	Ordering No.	Casting No.
	Length	Width	Thickness			
28	15-1/8 [384]	15-1/8 [384]	3/4 [19]	77	P537-DG-GRATE	57407-1

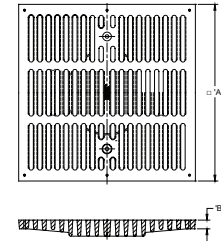

Z575						
Item No.	Dimensions in inches [mm]			Open Area. Sq. In.	Ordering No.	Casting No.
	Length	Width	Thickness			
29	12 [305]	5-1/8 [130]	11/16 [17]	24	P575-GRATE-USA	7723-1

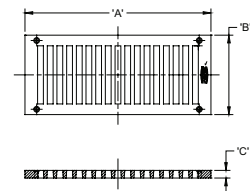

Z609						
Item No.	Dimensions in inches [mm]			Open Area. Sq. In.	Ordering No.	Casting No.
	Length	Width	Thickness			
30	8-5/16 [211]	8-5/16 [211]	5/8 [16]	20	P550-T-GRATE-USA	56653-1

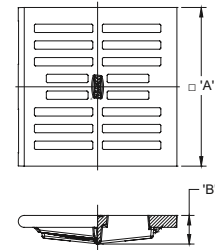

⚠ **WARNING:** Cancer and Reproductive Harm - www.P65Warnings.ca.gov
 ⚠ **ADVERTENCIA:** Cáncer y daño reproductivo - www.P65Warnings.ca.gov
 ⚠ **AVERTISSEMENT:** Cancer et effets néfastes sur la reproduction - www.P65Warnings.ca.gov

Zurn Industries, LLC | Specification Drainage Operation
 1801 Pittsburgh Avenue, Erie, PA 16502, Ph. 855.663.9876

In Canada | Zurn Industries Limited
 7900 Goreway Drive, Unit 10, Brampton, Ontario L6T 5W6, Ph. 877.892.5216

www.zurn.com

Rev. -
 Date: 12/06/23
 C.N. No. 145578
 Prod. | Dwg. No. FD138



SQUARE GRATE/COVER REPLACEMENTS

Z610, Z505-T, Z509-T, Z512-T, Z535-CI, Z539-T, Z645, Z761

Item No.	Dimensions in inches [mm]			Open Area. Sq. In.	Ordering No.	Casting No.
	Length	Width	Thickness			
31	11-3/8 [289]	11-3/8 [289]	11/16 [17]	42	P610-GRATE	56644-1

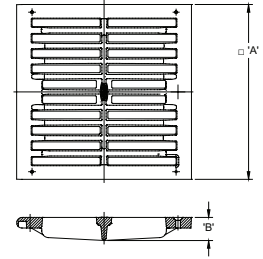

Z610-DS, Z610-SC

Item No.	Dimensions in inches [mm]			Open Area. Sq. In.	Ordering No.	Casting No.
	Length	Width	Thickness			
32	11-3/8 [289]	11-3/8 [289]	11/16 [17]	42	P610-DS-HC-USA	61755-1

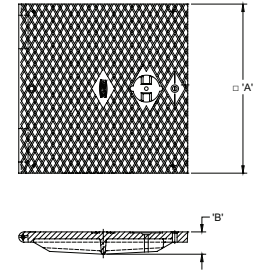

Z611

Item No.	Dimensions in inches [mm]			Open Area. Sq. In.	Ordering No.	Casting No.
	Length	Width	Thickness			
33	8-3/8 [213]	8-3/8 [213]	1/2 [13]	27	P611-GRATE	46121-1

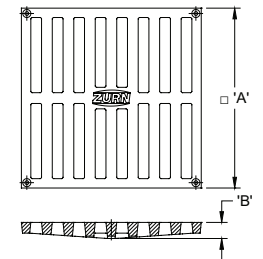

Z505-HT, Z509-HT, Z761

Item No.	Dimensions in inches [mm]			Open Area. Sq. In.	Ordering No.	Casting No.
	Length	Width	Thickness			
34	11-3/8 [289]	11-3/8 [289]	11/16 [17]	42	P610-H-GRATE	56644-8

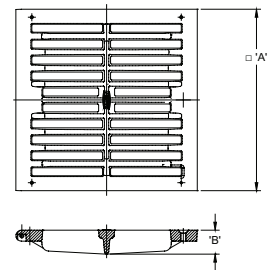

Z662, Z1920, Z1926 "Full Grate"

Item No.	Dimensions in inches [mm]			Open Area. Sq. In.	Ordering No.	Casting No.
	Length	Width	Thickness			
35	13-1/4 [337]	13-1/4 [337]	3/8 [10]	52	P662-GRATE-USA	46679-1

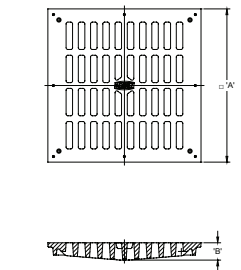

⚠ WARNING: Cancer and Reproductive Harm - www.P65Warnings.ca.gov
⚠ ADVERTENCIA: Cáncer y daño reproductivo - www.P65Warnings.ca.gov
⚠ AVERTISSEMENT: Cancer et effets néfastes sur la reproduction - www.P65Warnings.ca.gov

Zurn Industries, LLC | Specification Drainage Operation
1801 Pittsburgh Avenue, Erie, PA 16502, Ph. 855.663.9876

In Canada | Zurn Industries Limited
7900 Goreway Drive, Unit 10, Brampton, Ontario L6T 5W6, Ph. 877.892.5216

www.zurn.com

Rev. -
 Date: 12/06/23
 C.N. No. 145578
 Prod. | Dwg. No. FD138



SQUARE GRATE/COVER REPLACEMENTS

Z662-HP						
Item No.	Dimensions in inches [mm]			Open Area. Sq. In.	Ordering No.	Casting No.
	Length	Width	Thickness			
36	13-1/4 [337]	13-1/4 [337]	3/8 [10]	51	P662-HP-GRATE	82965-1

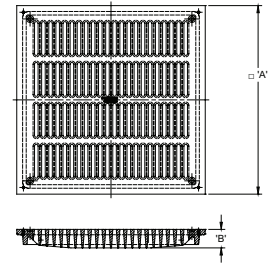

Z662-HF						
Item No.	Dimensions in inches [mm]			Open Area. Sq. In.	Ordering No.	Casting No.
	Length	Width	Thickness			
37	13-1/4 [337]	13 1/4 [337]	3/8 [10]	103	P662-GRATE-103	82669-1

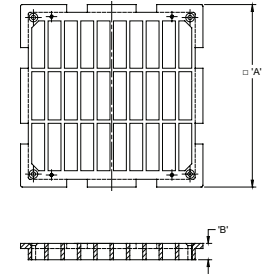

Z664						
Item No.	Dimensions in inches [mm]			Open Area. Sq. In.	Ordering No.	Casting No.
	Length	Width	Thickness			
38	11-15/16 [303]	5-1/4 [133]	7/16 [11]	14	P664-GRATE	51164-1

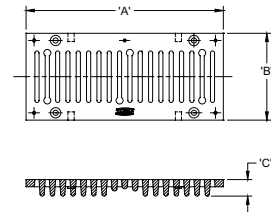

Z664-SQ						
Item No.	Dimensions in inches [mm]			Open Area. Sq. In.	Ordering No.	Casting No.
	Length	Width	Thickness			
39	11-15/16 [303]	5-1/4 [133]	7/16 [11]	12	P664-SQ-GRATE-USA	83194-1

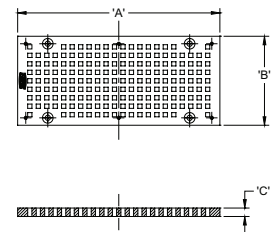

Z665						
Item No.	Dimensions in inches [mm]			Open Area. Sq. In.	Ordering No.	Casting No.
	Length	Width	Thickness			
40	11-15/16 [303]	11 [279]	3/4 [19]	35	P665-GRATE-USA	51468-1

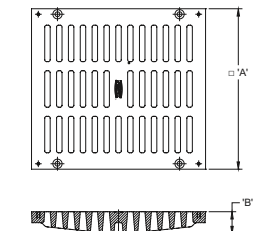

⚠ **WARNING:** Cancer and Reproductive Harm - www.P65Warnings.ca.gov
 ⚠ **ADVERTENCIA:** Cáncer y daño reproductivo - www.P65Warnings.ca.gov
 ⚠ **AVERTISSEMENT:** Cancer et effets néfastes sur la reproduction - www.P65Warnings.ca.gov

Zurn Industries, LLC | Specification Drainage Operation
 1801 Pittsburgh Avenue, Erie, PA 16502, Ph. 855.663.9876

In Canada | Zurn Industries Limited
 7900 Goreway Drive, Unit 10, Brampton, Ontario L6T 5W6, Ph. 877.892.5216

www.zurn.com

Rev. -
 Date: 12/06/23
 C.N. No. 145578
 Prod. | Dwg. No. FD138



SQUARE GRATE/COVER REPLACEMENTS

Z665-SQ						
Item No.	Dimensions in inches [mm]			Open Area. Sq. In.	Ordering No.	Casting No.
	Length	Width	Thickness			
41	11-15/16 [303]	11 [279]	3/4 [19]	47	825990011	82599-1

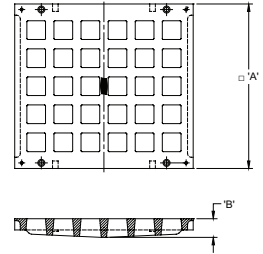

Z667						
Item No.	Dimensions in inches [mm]			Open Area. Sq. In.	Ordering No.	Casting No.
	Length	Width	Thickness			
42	14-15/16 [379]	4-7/8 [124]	1/4 [6]	27	P667-GRATE-USA	50566-1

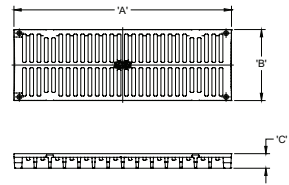

Z668						
Item No.	Dimensions in inches [mm]			Open Area. Sq. In.	Ordering No.	Casting No.
	Length	Width	Thickness			
43	18 [457]	10 [254]	1/4 [6]	51	P668-GRATE-USA	21528-1

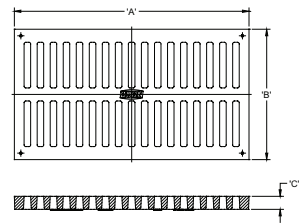

Z673						
Item No.	Dimensions in inches [mm]			Open Area. Sq. In.	Ordering No.	Casting No.
	Length	Width	Thickness			
44	24 [610]	11-1/2 [292]	1-9/16 [40]	83	826770017	82677-1

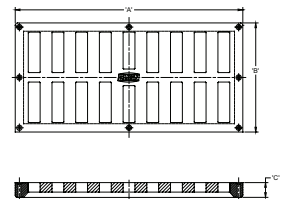

Z675						
Item No.	Dimensions in inches [mm]			Open Area. Sq. In.	Ordering No.	Casting No.
	Length	Width	Thickness			
45	9-9/16 [243]	9-9/16 [243]	1/2 [13]	72	P675-DG-GRATE	46576-1

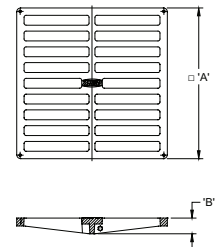

⚠ **WARNING:** Cancer and Reproductive Harm - www.P65Warnings.ca.gov
 ⚠ **ADVERTENCIA:** Cáncer y daño reproductivo - www.P65Warnings.ca.gov
 ⚠ **AVERTISSEMENT:** Cancer et effets néfastes sur la reproduction - www.P65Warnings.ca.gov

Zurn Industries, LLC | Specification Drainage Operation
1801 Pittsburgh Avenue, Erie, PA 16502, Ph. 855.663.9876

In Canada | Zurn Industries Limited
7900 Goreway Drive, Unit 10, Brampton, Ontario L6T 5W6, Ph. 877.892.5216

www.zurn.com

Rev. -
 Date: 12/06/23
 C.N. No. 145578
 Prod. | Dwg. No. FD138



SQUARE GRATE/COVER REPLACEMENTS

Z676						
Item No.	Dimensions in inches [mm]			Open Area. Sq. In.	Ordering No.	Casting No.
	Length	Width	Thickness			
46	11-5/8 [295]	11-5/8 [295]	23/32 [18]	72	P676-DG-GRATE	46680-1

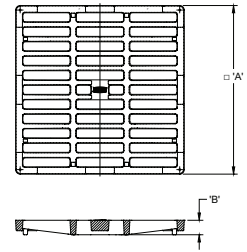

Z1739						
Item No.	Dimensions in inches [mm]			Open Area. Sq. In.	Ordering No.	Casting No.
	Length	Width	Thickness			
47	8-9/16 [217]	6-3/16 [157]	5/16 [8]	20	P1739-3-4-GRATE	04179-2

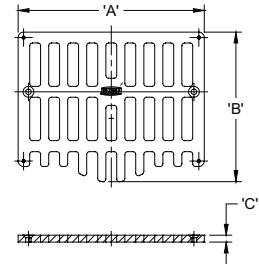

Z1749, Z1750, Z1751, Z1752 Full Grate						
Item No.	Dimensions in inches [mm]			Open Area. Sq. In.	Ordering No.	Casting No.
	Length	Width	Thickness			
48	9-3/4 [248]	9-3/4 [248]	15/16 [24]	24	P1750-GRATE-OV	57065-1

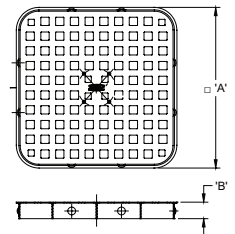

Z1749, Z1750, Z1751, Z1752 (-2 Half Grate)						
Item No.	Dimensions in inches [mm]			Open Area. Sq. In.	Ordering No.	Casting No.
	Length	Width	Thickness			
49	9-3/4 [248]	9-3/4 [248]	15/16 [24]	46	PM1750-2-GRATE	57065-3

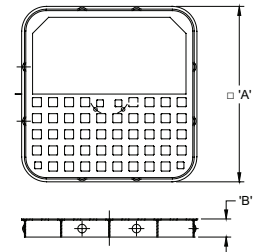

Z1749, Z1750, Z1751, Z1752 (-3 Three Quarter Grate)						
Item No.	Dimensions in inches [mm]			Open Area. Sq. In.	Ordering No.	Casting No.
	Length	Width	Thickness			
50	9-3/4 [248]	9-3/4 [248]	15/16 [24]	34	P1750-3-GRATE	57065-2

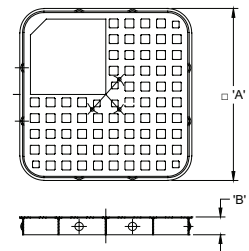

⚠ **WARNING:** Cancer and Reproductive Harm - www.P65Warnings.ca.gov
 ⚠ **ADVERTENCIA:** Cáncer y daño reproductivo - www.P65Warnings.ca.gov
 ⚠ **AVERTISSEMENT:** Cancer et effets néfastes sur la reproduction - www.P65Warnings.ca.gov

Zurn Industries, LLC | Specification Drainage Operation
1801 Pittsburgh Avenue, Erie, PA 16502, Ph. 855.663.9876

In Canada | Zurn Industries Limited
7900 Goreway Drive, Unit 10, Brampton, Ontario L6T 5W6, Ph. 877.892.5216

www.zurn.com

Rev. -
 Date: 12/06/23
 C.N. No. 145578
 Prod. | Dwg. No. FD138



SQUARE GRATE/COVER REPLACEMENTS

Z1749, Z1750, Z1751, Z1752 (-4 Full Grate with Square Center Opening)						
Item No.	Dimensions in inches [mm]			Open Area. Sq. In.	Ordering No.	Casting No.
	Length	Width	Thickness			
51	9-3/4 [248]	9-3/4 [248]	15/16 [2]	31	P1750-4-GRATE-OV	57065-4

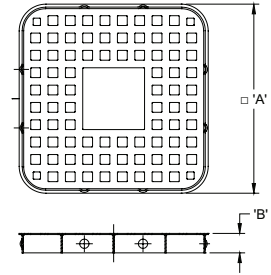

Z1749, Z1750, Z1751, Z1752 (-15 Solid Cover)						
Item No.	Dimensions in inches [mm]			Open Area. Sq. In.	Ordering No.	Casting No.
	Length	Width	Thickness			
52	9-3/4 [248]	9-3/4 [248]	15/16 [2]	-	P1750-15	57065-5

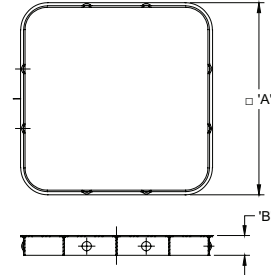

Z1749, Z1750, Z1751, Z1752 (-16 Half Solid Cover)						
Item No.	Dimensions in inches [mm]			Open Area. Sq. In.	Ordering No.	Casting No.
	Length	Width	Thickness			
53	9-3/4 [248]	9-3/4 [248]	15/16 [2]	34	P1750-16	57065-7

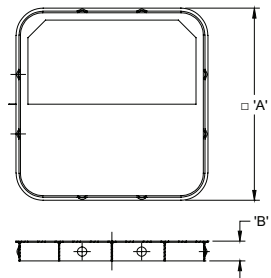

Z1749, Z1750, Z1751, Z1752 (-HD Heavy Duty Grate)						
Item No.	Dimensions in inches [mm]			Open Area. Sq. In.	Ordering No.	Casting No.
	Length	Width	Thickness			
54	9-9/16	9-9/16 [243]	7/8 [22]	24	P1750-HD-GRATE-OV	59208-1

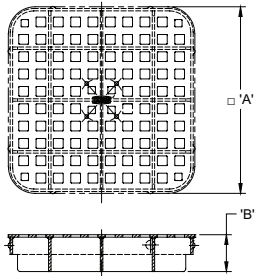

Z1749, Z1750, Z1751, Z1752 (-HD Heavy Duty Half Grate)						
Item No.	Dimensions in inches [mm]			Open Area. Sq. In.	Ordering No.	Casting No.
	Length	Width	Thickness			
55	9-9/16 [243]	9-9/16 [243]	7/8 [22]	46	592080035	59208-1

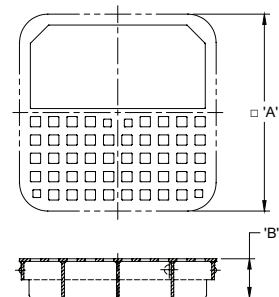

⚠ **WARNING:** Cancer and Reproductive Harm - www.P65Warnings.ca.gov
 ⚠ **ADVERTENCIA:** Cáncer y daño reproductivo - www.P65Warnings.ca.gov
 ⚠ **AVERTISSEMENT:** Cancer et effets néfastes sur la reproduction - www.P65Warnings.ca.gov

Zurn Industries, LLC | Specification Drainage Operation
 1801 Pittsburgh Avenue, Erie, PA 16502, Ph. 855.663.9876

In Canada | Zurn Industries Limited
 7900 Goreway Drive, Unit 10, Brampton, Ontario L6T 5W6, Ph. 877.892.5216

www.zurn.com

Rev. -
 Date: 12/06/23
 C.N. No. 145578
 Prod. | Dwg. No. FD138



SQUARE GRATE/COVER REPLACEMENTS

Z1749, Z1750, Z1751, Z1752 (-HP Heel Proof Grate)						
Item No.	Dimensions in inches [mm]			Open Area. Sq. In.	Ordering No.	Casting No.
	Length	Width	Thickness			
56	9-3/4 [248]	9-3/4 [248]	15/16 [2]	24	P1750-HP-GRATE	61445-1

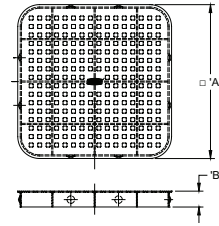

Z1749, Z1750, Z1751, Z1752 (-HP -2 Half Grate)						
Item No.	Dimensions in inches [mm]			Open Area. Sq. In.	Ordering No.	Casting No.
	Length	Width	Thickness			
57	9-3/4 [248]	9-3/4 [248]	15/16 [2]	46	P1750-HP-2-GRATE	61445-3

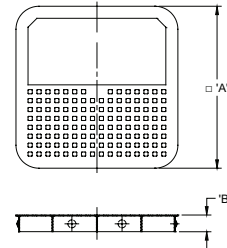

Z1749, Z1750, Z1751, Z1752 (-HP -3 Three Quarter Grate)						
Item No.	Dimensions in inches [mm]			Open Area. Sq. In.	Ordering No.	Casting No.
	Length	Width	Thickness			
58	9-3/4 [248]	9-3/4 [248]	15/16 [2]	34	P1750-HP-3-GRATE	61445-2

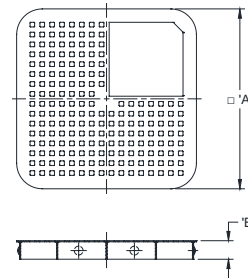

Z1749, Z1750, Z1751, Z1752 (-HP -4 Full Grate with Square Center Opening)						
Item No.	Dimensions in inches [mm]			Open Area. Sq. In.	Ordering No.	Casting No.
	Length	Width	Thickness			
59	9-3/4 [248]	9-3/4 [248]	15/16 [2]	31	P1750-HP-4-GRATE	61445-4

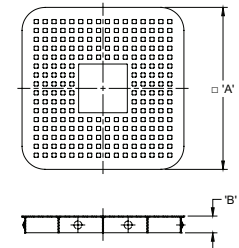

Z1755						
Item No.	Dimensions in inches [mm]			Open Area. Sq. In.	Ordering No.	Casting No.
	Length	Width	Thickness			
60	9-1/2 [241]	9-1/2 [241]	1-1/64 [26]	25	P1755-GRATE	82847

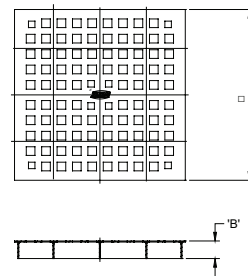

⚠ **WARNING:** Cancer and Reproductive Harm - www.P65Warnings.ca.gov
 ⚠ **ADVERTENCIA:** Cáncer y daño reproductivo - www.P65Warnings.ca.gov
 ⚠ **AVERTISSEMENT:** Cancer et effets néfastes sur la reproduction - www.P65Warnings.ca.gov

Zurn Industries, LLC | Specification Drainage Operation
1801 Pittsburgh Avenue, Erie, PA 16502, Ph. 855.663.9876

In Canada | Zurn Industries Limited
7900 Goreway Drive, Unit 10, Brampton, Ontario L6T 5W6, Ph. 877.892.5216

www.zurn.com

Rev. -
 Date: 12/06/23
 C.N. No. 145578
 Prod. | Dwg. No. FD138



SQUARE GRATE/COVER REPLACEMENTS

Z1755 -2 Half Grate						
Item No.	Dimensions in inches [mm]			Open Area. Sq. In.	Ordering No.	Casting No.
	Length	Width	Thickness			
61	9-1/2 [241]	9-1/2 [241]	1-1/64 [26]	48	P1755-2-GRATE	82847-2

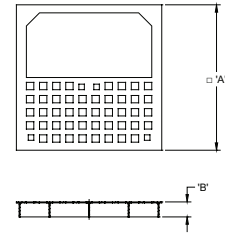

Z1755 - 3 Three quarter grate						
Item No.	Dimensions in inches [mm]			Open Area. Sq. In.	Ordering No.	Casting No.
	Length	Width	Thickness			
62	9-1/2 [241]	9-1/2 [241]	1-1/64 [26]	35	P1755-3-GRATE	82847-3

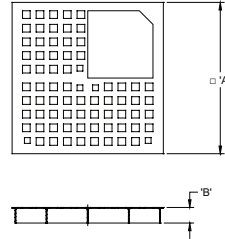

Z1761						
Item No.	Dimensions in inches [mm]			Open Area. Sq. In.	Ordering No.	Casting No.
	Length	Width	Thickness			
63	24 [610]	24 [610]	1 [25]	425	671530015	67153-1

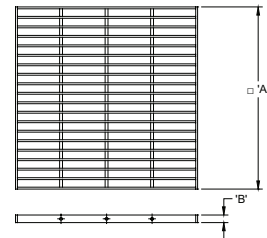

Z1762 (Uses 2 grates)						
Item No.	Dimensions in inches [mm]			Open Area. Sq. In.	Ordering No.	Casting No.
	Length	Width	Thickness			
64	12-1/4 [311]	12 [305]	1 [25]	149	629590015	62595-1

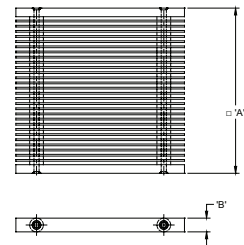

Z1763 (Uses 2 Grates)						
Item No.	Dimensions in inches [mm]			Open Area. Sq. In.	Ordering No.	Casting No.
	Length	Width	Thickness			
65	22-1/8 [562]	12-1/4 [311]	1 [25]	431	621910015	62191-1

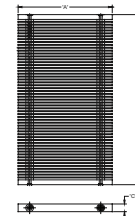

⚠ **WARNING:** Cancer and Reproductive Harm - www.P65Warnings.ca.gov
 ⚠ **ADVERTENCIA:** Cáncer y daño reproductivo - www.P65Warnings.ca.gov
 ⚠ **AVERTISSEMENT:** Cancer et effets néfastes sur la reproduction - www.P65Warnings.ca.gov

Zurn Industries, LLC | Specification Drainage Operation
 1801 Pittsburgh Avenue, Erie, PA 16502, Ph. 855.663.9876

In Canada | Zurn Industries Limited
 7900 Goreway Drive, Unit 10, Brampton, Ontario L6T 5W6, Ph. 877.892.5216

www.zurn.com

Rev. -
 Date: 12/06/23
 C.N. No. 145578
 Prod. | Dwg. No. FD138



SQUARE GRATE/COVER REPLACEMENTS

Z1910						
Item No.	Dimensions in inches [mm]			Open Area. Sq. In.	Ordering No.	Casting No.
	Length	Width	Thickness			
66	7-1/4 [184]	7-1/4 [184]	1/8 [3]	20	P1910-FULL-GRATE	56756-1

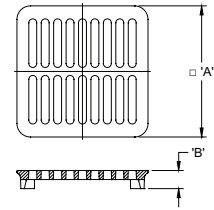

Z1910 -2 Half grate						
Item No.	Dimensions in inches [mm]			Open Area. Sq. In.	Ordering No.	Casting No.
	Length	Width	Thickness			
67	7-1/4 [184]	7-1/4 [184]	1/8 [3]	26	P1910-2-GRATE	56756-3

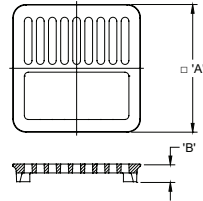

Z1910 -3 Three Quarter Grate						
Item No.	Dimensions in inches [mm]			Open Area. Sq. In.	Ordering No.	Casting No.
	Length	Width	Thickness			
68	7-1/4 [184]	7-1/4 [184]	1/8 [3]	23	P1910-3-GRATE	56756-2

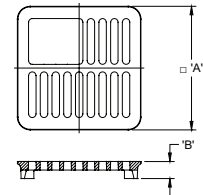

Z1910 -4 Full Grate with Center Opening						
Item No.	Dimensions in inches [mm]			Open Area. Sq. In.	Ordering No.	Casting No.
	Length	Width	Thickness			
69	7-1/4 [184]	7-1/4 [184]	1/8 [3]	21	P1910-4-GRATE	56756-4

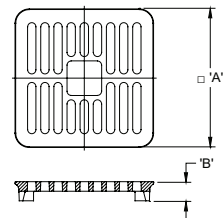

Z1910 -15 Solid Loose Set Cover						
Item No.	Dimensions in inches [mm]			Open Area. Sq. In.	Ordering No.	Casting No.
	Length	Width	Thickness			
70	7-1/4 [184]	7-1/4 [184]	3/16 [5]	-	P1910-15-COVER-USA	57227-1

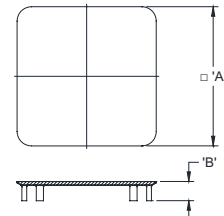

⚠ WARNING: Cancer and Reproductive Harm - www.P65Warnings.ca.gov
⚠ ADVERTENCIA: Cáncer y daño reproductivo - www.P65Warnings.ca.gov
⚠ AVERTISSEMENT: Cancer et effets néfastes sur la reproduction - www.P65Warnings.ca.gov

Zurn Industries, LLC | Specification Drainage Operation
 1801 Pittsburgh Avenue, Erie, PA 16502, Ph. 855.663.9876

In Canada | Zurn Industries Limited
 7900 Goreway Drive, Unit 10, Brampton, Ontario L6T 5W6, Ph. 877.892.5216

www.zurn.com

Rev. -
 Date: 12/06/23
 C.N. No. 145578
 Prod. | Dwg. No. FD138



SQUARE GRATE/COVER REPLACEMENTS

Z1910 -19 Hinged Full Grate						
Item No.	Dimensions in inches [mm]			Open Area. Sq. In.	Ordering No.	Casting No.
	Length	Width	Thickness			
71	7-11/16 [195]	5-1/2 [140]	1/8 [3]	14	PN1910-19-STR	36689-2

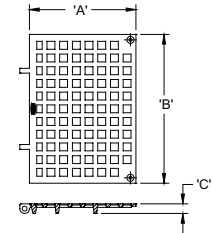

Z1910 -19 Hinged Half Grate						
Item No.	Dimensions in inches [mm]			Open Area. Sq. In.	Ordering No.	Casting No.
	Length	Width	Thickness			
72	7-11/16 [195]	5-1/2 [140]	1/8 [3]	29	PN1910-2-19-GRATE	36689-4

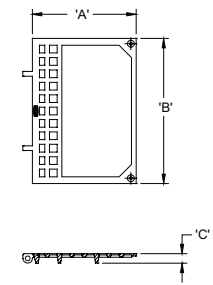

Z1910 -19 Full Hinged Three Quarter Grate						
Item No.	Dimensions in inches [mm]			Open Area. Sq. In.	Ordering No.	Casting No.
	Length	Width	Thickness			
73	7-11/16 [195]	5-1/2 [140]	1/8 [3]	21	PN1910-3-19-GRATE	36689-5

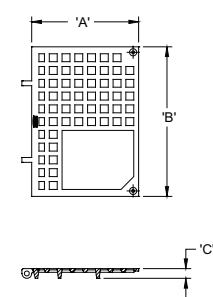

Z1910-RL						
Item No.	Dimensions in inches [mm]			Open Area. Sq. In.	Ordering No.	Casting No.
	Length	Width	Thickness			
74	6-15/32 [164]	6-15/32 [164]	1/2 [13]	12	3117020015	311702-1

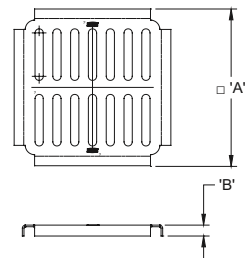

Z1910-RL -2 Half Grate						
Item No.	Dimensions in inches [mm]			Open Area. Sq. In.	Ordering No.	Casting No.
	Length	Width	Thickness			
75	6-15/32 [164]	6-15/32 [164]	1/2 [13]	20	3117020025	311702-2

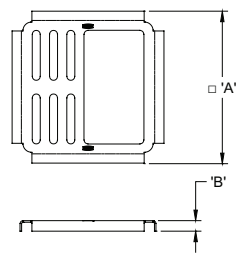

⚠ **WARNING:** Cancer and Reproductive Harm - www.P65Warnings.ca.gov
 ⚠ **ADVERTENCIA:** Cáncer y daño reproductivo - www.P65Warnings.ca.gov
 ⚠ **AVERTISSEMENT:** Cancer et effets néfastes sur la reproduction - www.P65Warnings.ca.gov

Zurn Industries, LLC | Specification Drainage Operation
1801 Pittsburgh Avenue, Erie, PA 16502, Ph. 855.663.9876

In Canada | Zurn Industries Limited
7900 Goreway Drive, Unit 10, Brampton, Ontario L6T 5W6, Ph. 877.892.5216

www.zurn.com

Rev. -
 Date: 12/06/23
 C.N. No. 145578
 Prod. | Dwg. No. FD138



SQUARE GRATE/COVER REPLACEMENTS

Z1910-RL -3 Three Quarter Grate

Item No.	Dimensions in inches [mm]			Open Area. Sq. In.	Ordering No.	Casting No.
	Length	Width	Thickness			
76	6-15/32 [164]	6-15/32 [164]	1/2 [13]	15	3117020035	311702-3

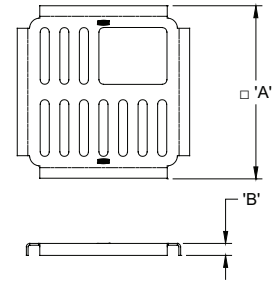

Z1920, Z1926 "Half Grate"

Item No.	Dimensions in inches [mm]			Open Area. Sq. In.	Ordering No.	Casting No.
	Length	Width	Thickness			
77	13-1/4 [337]	13-1/4 [337]	3/8 [10]	79	P1920-2-GRATE	46679-3

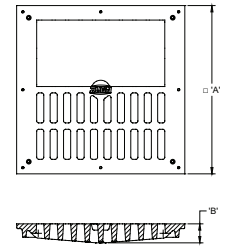

Z1920, Z1926 "3/4 Grate"

Item No.	Dimensions in inches [mm]			Open Area. Sq. In.	Ordering No.	Casting No.
	Length	Width	Thickness			
78	13-1/4 [337]	13-1/4 [337]	3/8 [10]	64	P1920-3-GRATE	46679-5

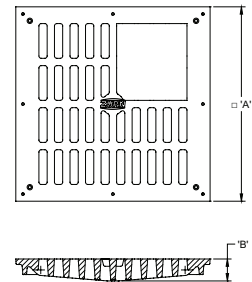

Z1920, Z1926 "Center Opening Grate"

Item No.	Dimensions in inches [mm]			Open Area. Sq. In.	Ordering No.	Casting No.
	Length	Width	Thickness			
79	13-1/4 [337]	13-1/4 [337]	3/8 [10]	62	P1920-4-GRATE	46679-8

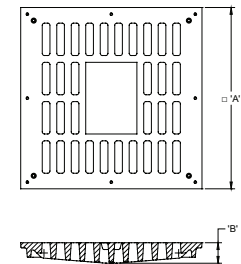

Z1920, Z1926 "Solid Cover"

Item No.	Dimensions in inches [mm]			Open Area. Sq. In.	Ordering No.	Casting No.
	Length	Width	Thickness			
80	13-1/4 [337]	13-1/4 [337]	3/8 [10]	-	P1920-15	57652-1

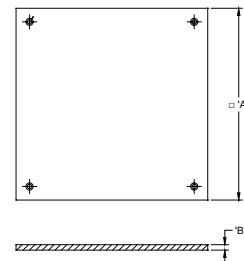

⚠ WARNING: Cancer and Reproductive Harm - www.P65Warnings.ca.gov

⚠ ADVERTENCIA: Cáncer y daño reproductivo - www.P65Warnings.ca.gov

⚠ AVERTISSEMENT: Cancer et effets néfastes sur la reproduction - www.P65Warnings.ca.gov

Zurn Industries, LLC | Specification Drainage Operation
1801 Pittsburgh Avenue, Erie, PA 16502, Ph. 855.663.9876

In Canada | Zurn Industries Limited
7900 Goreway Drive, Unit 10, Brampton, Ontario L6T 5W6, Ph. 877.892.5216

www.zurn.com

Rev. -
Date: 12/06/23
C.N. No. 145578
Prod. | Dwg. No. FD138



SQUARE GRATE/COVER REPLACEMENTS

Z1930 Full Grate, Z1720						
Item No.	Dimensions in inches [mm]			Open Area. Sq. In.	Ordering No.	Casting No.
	Length	Width	Thickness			
81	7-17/32 [191]	3-9/16 [90]	5/16 [8]	-	P1930-FULL-GRATE	304303-1

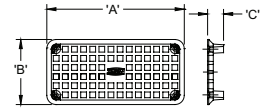

Z1970 Half Grate						
Item No.	Dimensions in inches [mm]			Open Area. Sq. In.	Ordering No.	Casting No.
	Length	Width	Thickness			
82	7-17/32 [191]	3-9/16 [90]	5/16 [8]	-	P1930-2-GRATE	304303-3

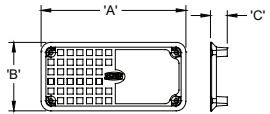

Z1930 3/4 Grate						
Item No.	Dimensions in inches [mm]			Open Area. Sq. In.	Ordering No.	Casting No.
	Length	Width	Thickness			
83	7-17/32 [191]	3-9/16 [90]	5/16 [8]	-	P1930-3-GRATE	304303-4

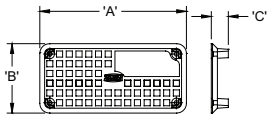

Z1930 Full grate with Center Opening						
Item No.	Dimensions in inches [mm]			Open Area. Sq. In.	Ordering No.	Casting No.
	Length	Width	Thickness			
84	7-17/32 [191]	3-9/16 [90]	5/16 [8]	-	P1930-4-GRATE	304303-7

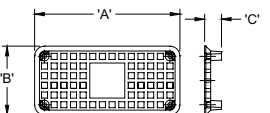

Z1930 Solid Cover						
Item No.	Dimensions in inches [mm]			Open Area. Sq. In.	Ordering No.	Casting No.
	Length	Width	Thickness			
85	7-13/32 [188]	3-7/16 [87]	3/16 [5]	-	P1930-15-COVER	307430-1

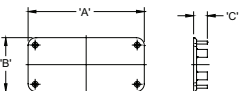

⚠ **WARNING:** Cancer and Reproductive Harm - www.P65Warnings.ca.gov
 ⚠ **ADVERTENCIA:** Cáncer y daño reproductivo - www.P65Warnings.ca.gov
 ⚠ **AVERTISSEMENT:** Cancer et effets néfastes sur la reproduction - www.P65Warnings.ca.gov

Zurn Industries, LLC | Specification Drainage Operation
 1801 Pittsburgh Avenue, Erie, PA 16502, Ph. 855.663.9876

In Canada | Zurn Industries Limited
 7900 Goreway Drive, Unit 10, Brampton, Ontario L6T 5W6, Ph. 877.892.5216

www.zurn.com

Rev. -
 Date: 12/06/23
 C.N. No. 145578
 Prod. | Dwg. No. FD138



SQUARE GRATE/COVER REPLACEMENTS

ZN1930 Full Grate						
Item No.	Dimensions in inches [mm]			Open Area. Sq. In.	Ordering No.	Casting No.
	Length	Width	Thickness			
86	7-5/8 [194]	3-5/8 [92]	3/16 [5]	-	PN1930-FULL-GRT-USA	50022-1

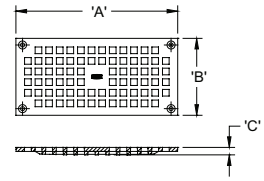

ZN1930 Half Grate						
Item No.	Dimensions in inches [mm]			Open Area. Sq. In.	Ordering No.	Casting No.
	Length	Width	Thickness			
87	7-5/8 [194]	3-5/8 [92]	3/16 [5]	-	PN1930-2-GRATE	50022-3

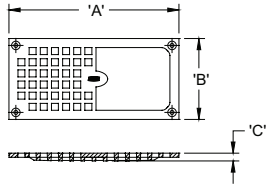

ZN1930 3/4 Grate						
Item No.	Dimensions in inches [mm]			Open Area. Sq. In.	Ordering No.	Casting No.
	Length	Width	Thickness			
88	7-5/8 [194]	3-5/8 [92]	3/16 [5]	-	PN1930-3-GRATE	50022-4

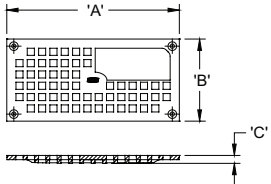

ZN1930 Full grate with Center Opening						
Item No.	Dimensions in inches [mm]			Open Area. Sq. In.	Ordering No.	Casting No.
	Length	Width	Thickness			
89	7-5/8 [194]	3-5/8 [92]	3/16 [5]	-	PN1930-4-GRATE	50022-7

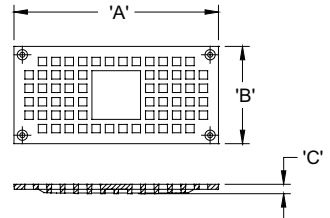

ZN1930 Solid Cover						
Item No.	Dimensions in inches [mm]			Open Area. Sq. In.	Ordering No.	Casting No.
	Length	Width	Thickness			
90	7-5/8 [194]	3-5/8 [92]	3/16 [5]	-	PN1930-15-COVER	50022-9

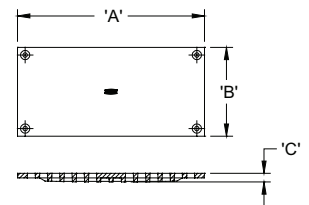

⚠ **WARNING:** Cancer and Reproductive Harm - www.P65Warnings.ca.gov
 ⚠ **ADVERTENCIA:** Cáncer y daño reproductivo - www.P65Warnings.ca.gov
 ⚠ **AVERTISSEMENT:** Cancer et effets néfastes sur la reproduction - www.P65Warnings.ca.gov

Zurn Industries, LLC | Specification Drainage Operation
 1801 Pittsburgh Avenue, Erie, PA 16502, Ph. 855.663.9876

In Canada | Zurn Industries Limited
 7900 Goreway Drive, Unit 10, Brampton, Ontario L6T 5W6, Ph. 877.892.5216

www.zurn.com

Rev. -
 Date: 12/06/23
 C.N. No. 145578
 Prod. | Dwg. No. FD138



SQUARE GRATE/COVER REPLACEMENTS

Z1940 Full Grate						
Item No.	Dimensions in inches [mm]			Open Area. Sq. In.	Ordering No.	Casting No.
	Length	Width	Thickness			
91	11-17/32 [293]	5-9/16 [141]	1/2 [13]	16	P1940-FULL-GRATE	302571-1

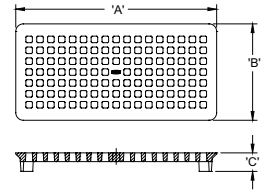

Z1940 Half Grate						
Item No.	Dimensions in inches [mm]			Open Area. Sq. In.	Ordering No.	Casting No.
	Length	Width	Thickness			
92	11-17/32 [293]	5-9/16 [141]	1/2 [13]	28	P1940-2-GRATE	302571-2

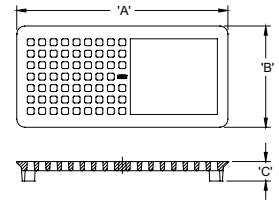

Z1940 3/4 Grate						
Item No.	Dimensions in inches [mm]			Open Area. Sq. In.	Ordering No.	Casting No.
	Length	Width	Thickness			
93	11-17/32 [293]	5-9/16 [141]	1/2 [13]	21	P1940-3-GRATE	302571-3

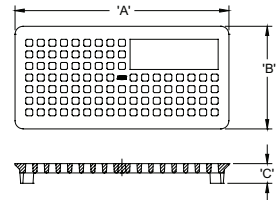

Z1940 Full Grate with Center Opening						
Item No.	Dimensions in inches [mm]			Open Area. Sq. In.	Ordering No.	Casting No.
	Length	Width	Thickness			
94	11-17/32 [293]	5-9/16 [141]	1/2 [13]	21	P1940-4-GRATE	302571-4

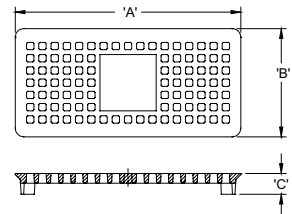

Z1940 Solid Cover						
Item No.	Dimensions in inches [mm]			Open Area. Sq. In.	Ordering No.	Casting No.
	Length	Width	Thickness			
95	11-17/32 [293]	5-9/16 [141]	1/2 [13]	-	P1940-15-COVER	302571-5

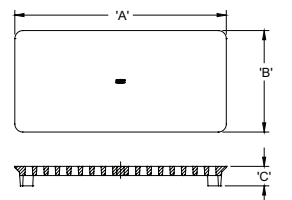

⚠ **WARNING:** Cancer and Reproductive Harm - www.P65Warnings.ca.gov
 ⚠ **ADVERTENCIA:** Cáncer y daño reproductivo - www.P65Warnings.ca.gov
 ⚠ **AVERTISSEMENT:** Cancer et effets néfastes sur la reproduction - www.P65Warnings.ca.gov

Zurn Industries, LLC | Specification Drainage Operation
 1801 Pittsburgh Avenue, Erie, PA 16502, Ph. 855.663.9876

In Canada | Zurn Industries Limited
 7900 Goreway Drive, Unit 10, Brampton, Ontario L6T 5W6, Ph. 877.892.5216

www.zurn.com

Rev. -
 Date: 12/06/23
 C.N. No. 145578
 Prod. | Dwg. No. FD138



SQUARE GRATE/COVER REPLACEMENTS

Z1940 Solid Cover with Square Center hole						
Item No.	Dimensions in inches [mm]			Open Area. Sq. In.	Ordering No.	Casting No.
	Length	Width	Thickness			
96	11-17/32 [293]	5-9/16 [141]	1/2 [13]	8	3025710081	302571-8

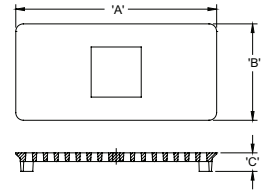

ZN1940 Full Grate						
Item No.	Dimensions in inches [mm]			Open Area. Sq. In.	Ordering No.	Casting No.
	Length	Width	Thickness			
97	11-7/8 [302]	5-7/8 [149]	3/16 [5]	16.2	PN1940-FULL-GRT-USA	53250-1

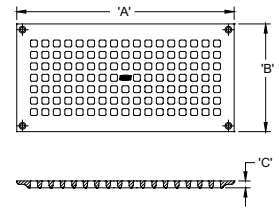

ZN1940 Half Grate						
Item No.	Dimensions in inches [mm]			Open Area. Sq. In.	Ordering No.	Casting No.
	Length	Width	Thickness			
98	11-7/8 [302]	5-7/8 [149]	3/16 [5]	28.1	PN1940-2-GRATE	53250-3

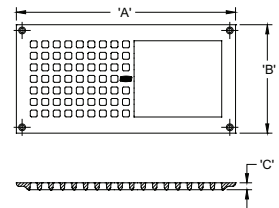

ZN1940 3/4 Grate						
Item No.	Dimensions in inches [mm]			Open Area. Sq. In.	Ordering No.	Casting No.
	Length	Width	Thickness			
99	11-7/8 [302]	5-7/8 [149]	3/16 [5]	20.6	PN1940-3-GRATE	53250-5

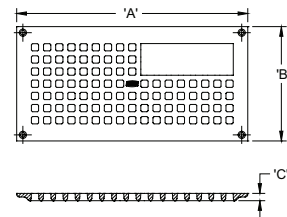

ZN1940 Full Grate with Center Opening						
Item No.	Dimensions in inches [mm]			Open Area. Sq. In.	Ordering No.	Casting No.
	Length	Width	Thickness			
100	11-7/8 [302]	5-7/8 [149]	3/16 [5]	20.9	PN1940-4-GRATE	53250-7

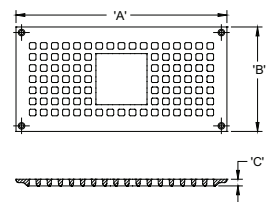

⚠ **WARNING:** Cancer and Reproductive Harm - www.P65Warnings.ca.gov
 ⚠ **ADVERTENCIA:** Cáncer y daño reproductivo - www.P65Warnings.ca.gov
 ⚠ **AVERTISSEMENT:** Cancer et effets néfastes sur la reproduction - www.P65Warnings.ca.gov

Zurn Industries, LLC | Specification Drainage Operation
 1801 Pittsburgh Avenue, Erie, PA 16502, Ph. 855.663.9876

In Canada | Zurn Industries Limited
 7900 Goreway Drive, Unit 10, Brampton, Ontario L6T 5W6, Ph. 877.892.5216

www.zurn.com

Rev. -
 Date: 12/06/23
 C.N. No. 145578
 Prod. | Dwg. No. FD138



SQUARE GRATE/COVER REPLACEMENTS

ZN1940 Solid Cover						
Item No.	Dimensions in inches [mm]			Open Area. Sq. In.	Ordering No.	Casting No.
	Length	Width	Thickness			
101	11-7/8 [302]	5-7/8 [149]	3/16 [5]	-	PN1940-15-COVER-USA	53250-9

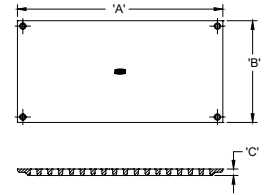

ZN1940 Solid Cover with Square Center hole						
Item No.	Dimensions in inches [mm]			Open Area. Sq. In.	Ordering No.	Casting No.
	Length	Width	Thickness			
102	11-7/8 [302]	5-7/8 [149]	3/16 [5]	8.1	PN1940-18-COVER	53250-16

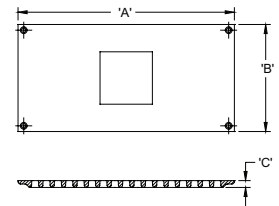

Z1982						
Item No.	Dimensions in inches [mm]			Open Area. Sq. In.	Ordering No.	Casting No.
	Length	Width	Thickness			
103	9-12/32 [238]	9-12/32 [238]	30/32 [24]	30.3	P1982-GRATE-OV	59207-4

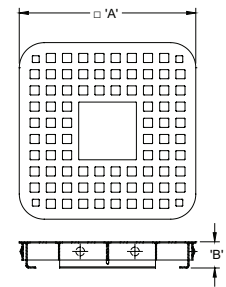

Z1995 Full Grate (2 x Grates per drain)						
Item No.	Dimensions in inches [mm]			Open Area. Sq. In.	Ordering No.	Casting No.
	Length	Width	Thickness			
104	15-3/8 [391]	11 11/16 [297]	1/2 [13]	35	P1995-GRATE	50315-4

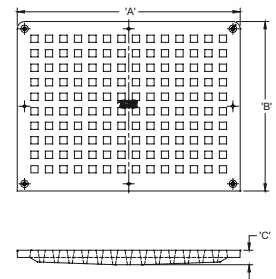

Z1995 -2 Half Grate (2 x Grates per drain)						
Item No.	Dimensions in inches [mm]			Open Area. Sq. In.	Ordering No.	Casting No.
	Length	Width	Thickness			
105	15-3/8 [391]	11 11/16 [297]	1/2 [13]	127	P1995-2-GRATE	50315-13

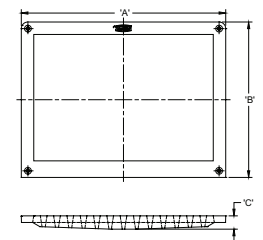

⚠ WARNING: Cancer and Reproductive Harm - www.P65Warnings.ca.gov
⚠ ADVERTENCIA: Cáncer y daño reproductivo - www.P65Warnings.ca.gov
⚠ AVERTISSEMENT: Cancer et effets néfastes sur la reproduction - www.P65Warnings.ca.gov

Zurn Industries, LLC | Specification Drainage Operation
1801 Pittsburgh Avenue, Erie, PA 16502, Ph. 855.663.9876

In Canada | Zurn Industries Limited
7900 Goreway Drive, Unit 10, Brampton, Ontario L6T 5W6, Ph. 877.892.5216

www.zurn.com

Rev. -
 Date: 12/06/23
 C.N. No. 145578
 Prod. | Dwg. No. FD138



SQUARE GRATE/COVER REPLACEMENTS

Z1995 -3 Three Quarter Grate (2 x Grates per drain)						
Item No.	Dimensions in inches [mm]			Open Area. Sq. In.	Ordering No.	Casting No.
	Length	Width	Thickness			
106	15-3/8 [391]	11 11/16 [297]	1/2 [13]	78	P1995-3-GRATE	50315-5

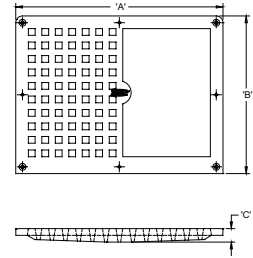

⚠ **WARNING:** Cancer and Reproductive Harm - www.P65Warnings.ca.gov
 ⚠ **ADVERTENCIA:** Cáncer y daño reproductivo - www.P65Warnings.ca.gov
 ⚠ **AVERTISSEMENT:** Cancer et effets néfastes sur la reproduction - www.P65Warnings.ca.gov

Zurn Industries, LLC | Specification Drainage Operation
 1801 Pittsburgh Avenue, Erie, PA 16502, Ph. 855.663.9876

In Canada | Zurn Industries Limited
 7900 Goreway Drive, Unit 10, Brampton, Ontario L6T 5W6, Ph. 877.892.5216

www.zurn.com

Rev. -
 Date: 12/06/23
 C.N. No. 145578
 Prod. | Dwg. No. FD138