



Model Z5004.03

TAG _____

Sundara® Surf Triple Basin Hand Washing System



PATENT(S) PENDING

Product Description

Designed for modern commercial restrooms, the Sundara system delivers a superior user experience in both form and function. Crafted by world-class industrial designers Sundara combines seamless basin designs with curated faucets and soap dispensers, delivering a complete, easy to install hand washing solution.

Architect/Engineer Specification

Sundara® Surf triple basin lavatory system manufactured by Zurn Industries. Lavatory shall be mounted at standard height to conform with ANSI, UFAS, TAS and ADA Accessibility Standards. Counter and integral basin to be constructed of Sundara® solid surface pure acrylic resin with aluminum trihydrate and other additives and conform to CSA B45.5/ IAPMO Z124 and IAPMO IGC 156 standards. Shroud enclosure is constructed of satin finished type 304, 18 gage stainless steel. Lavatory is furnished complete with 0.5 gpm spray aerator faucet (specify model in sensor or manual) and optional liquid soap dispenser (specify model), 1/2" quarter turn supply stops, 3/8" flexible supply risers, chrome 1 1/2" tail piece, and chrome 1 1/2" p-trap for complete system operation.

Product Features

- Sundara® engineered solid surface
- Available in multiple colors
- Matched soap and faucet options
- Stainless steel shroud, vandal resistant and easy to install
- Non-splash basin design
- Left or right side integrated soap hole
- Zurn One orders include all required components for installation and Z8700 series P trap along with Z8802 series supply stops with 16" flexible supplies
- Provided with chrome finish faucet, soap dispenser and grid drain. Select product available in alternate finishes
- Provided with mounting bracket and wall bracket with necessary hardware for ease of installation
- Integral overflow

Standards Compliance

- ADA Compliant
- Lead Free Compliant
- NSF/ANSI 61-9 (applicable to Faucet)
- Texas Accessibility Standard (TAS)



Conforms to:

- ASME A112.18.1/CSA B125.1
- ASME A112.18.2/CSA B125.2 (Applicable to Waste Fitting)
- ASME A112.6.1M (applicable to Carrier)
- CSA B45.5 / Z124
- IGC 156

Meets the American Disabilities Guidelines and ANSI A117.1 requirements when lavatory is installed 34" [864mm] from finished floor.

In Canada - Consult local codes and standards.

All dimensions and specifications are subject to change without notice.





Model Z5004.03

Sundara® Surf Triple Basin Hand Washing System

Faucet (must select one)

Sensor Faucet



Z6950-XL-F



Z6951-XL-F



Z6953-XL-F



Z6954-XL-F



Z6955-XL-F



Z6956-XL-F

Manual Faucet



Z7440-XL-FC



Z81000-XL-3M



Z81101-XL-3M



Z81104-XL-3M



Z812B4-XL-3F



Z86100-XL-3M



Z86500-XL-3M

Sensor Faucet Power Supply Option

-HW6 : Hardwired Power Converter

-LL : "10 Year Battery" -Long Life

Sensor Faucet Mixing Option

-No Mixing

-MV : Temperature Mixing Valve

-TMV-1 : Temperature Mixing Valve for Single Faucet

Soap Dispenser (must select one)

Sensor Soap Dispenser



Z6950-SD



Z6951-SD



Z6953-SD



Z6954-SD



Z6956-SD

Manual Soap Dispenser



Z86100-SD

Position (For Manual Only)

Left

Right

No Soap Hole

Position (For Sensor Only)

Left

Right

No Soap Hole

Alternate Finishes

(Applies to sensor operated faucet, corresponding soap and grid drain)

BN : Brushed Nickel (01)

PN : Polished Nickel (02)

PB : Polished Brass (03)



(01)



(02)

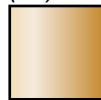

(03)

Colors (must select one)

White (01)

Snow (02)

Sea Shell (03)

HighCliffe (04)

Sand Storm (05)

Alluvium (06)

Frost (07)



(01)



(02)

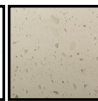

(03)

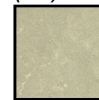

(04)



(05)

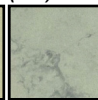

(06)

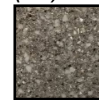

(07)

Recommended Hanging Apparatus

Z1240-EZR Sundara lavatory carrier

Meets the American Disabilities Guidelines and ANSI A117.1 requirements when lavatory is installed 34" [864mm] from finished floor.

In Canada - Consult local codes and standards.

All dimensions and specifications are subject to change without notice.



Model Z5004.03

Sundara® Surf Triple Basin Hand Washing System

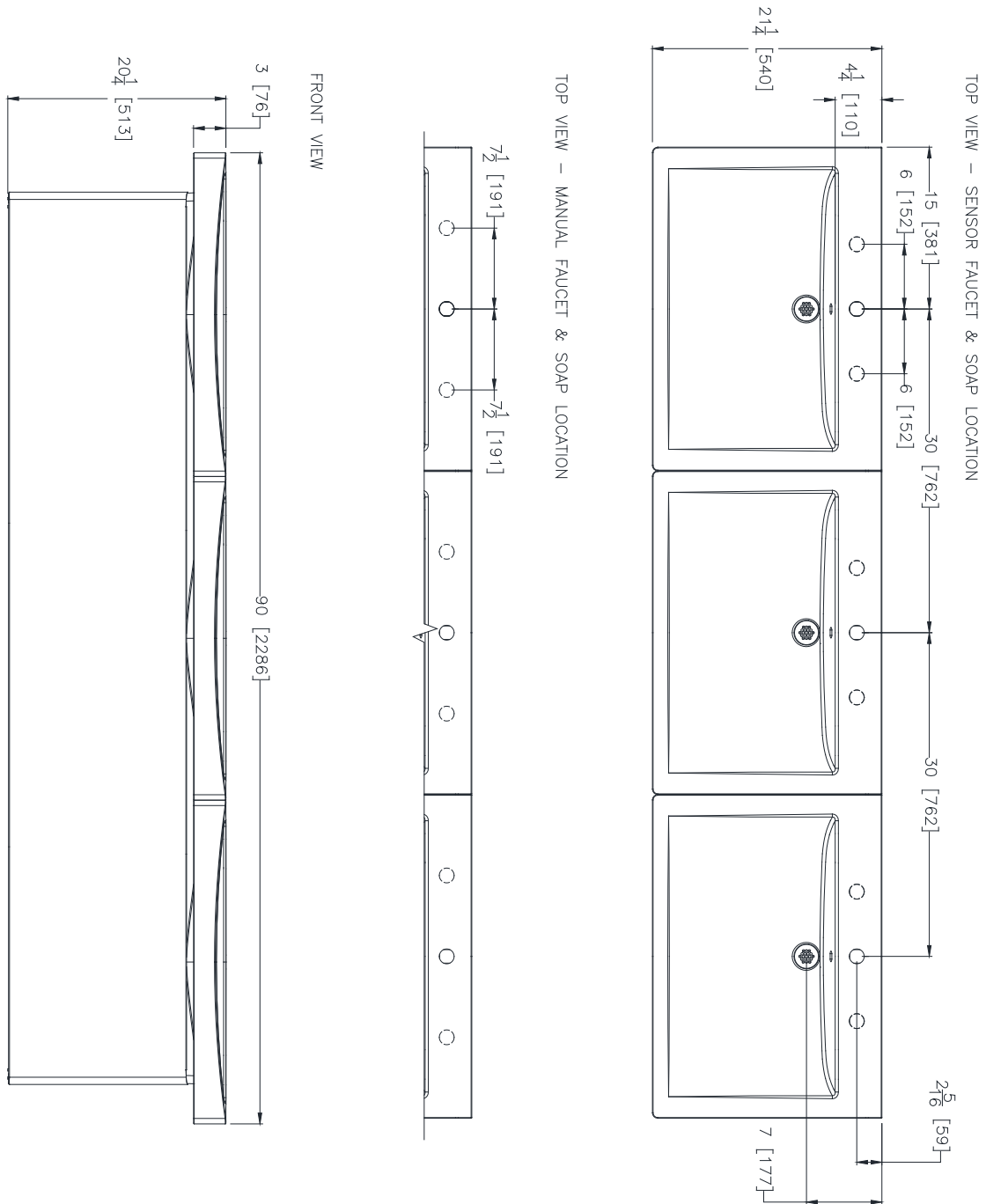

Meets the American Disabilities Guidelines and ANSI A117.1 requirements when lavatory is installed 34" [864mm] from finished floor.

In Canada - Consult local codes and standards.

All dimensions and specifications are subject to change without notice.



Model Z5004.03

Sundara® Surf Triple Basin Hand Washing System

SIDE VIEW

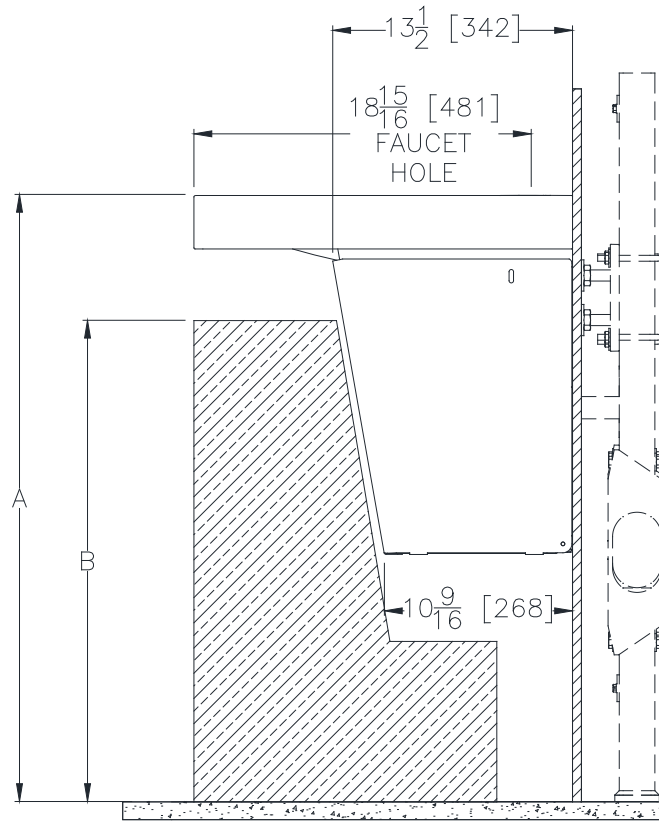

**Shown with optional Sundara Z1240-EZR-WL*

	ADA/TAS Regular Height	TAS Juvenile Height (Children 11-14 years)	ADA Juvenile Height (Children 6-12 years)	CSA Regular Height	OBC Regular Height
A	34"(863mm)	32"(812mm)	31"(787mm)	32 1/4 (820mm)	33"(838mm)
B	27"(686mm)	28"(712mm)	24"(610mm)	26 13/16"(680mm)	27"(686mm)

Meets the American Disabilities Guidelines and ANSI A117.1 requirements when lavatory is installed 34" [864mm] from finished floor.

In Canada - Consult local codes and standards.

All dimensions and specifications are subject to change without notice.



Model Z5004.03

Sundara® Surf Triple Basin Hand Washing System

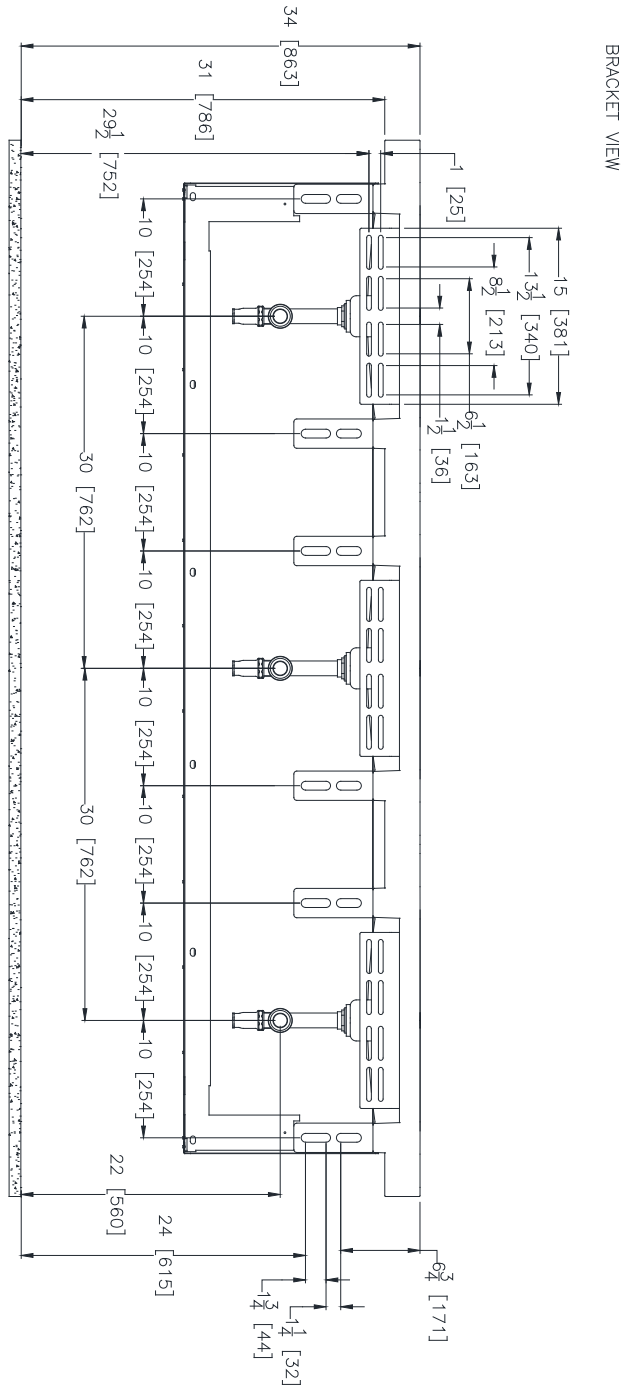

Meets the American Disabilities Guidelines and ANSI A117.1 requirements when lavatory is installed 34" [864mm] from finished floor.

In Canada - Consult local codes and standards.

All dimensions and specifications are subject to change without notice.