



Zurn Engineered Water Solutions™

Spec-Tran™ Specified Transportation Systems



Airports



Highways



Ports



Rail Stations

Drainage for Safe Transportation

www.zurn.com



Spec-Tran™

Specified Transportation Systems

Table of Contents

Page No.

6" Pre-sloped Trench Drains - Polyethylene

Z886-HDD and -HR	2
Z886-FGF – Class F System	3
Z886 Trench Drain Inverts – Sidewall Extensions	4
Z886 Outlet Fabrication	5

12" Pre-sloped Trench Drains - Polyethylene

Z882-DGC	6
Z882-DGF	6
Z882 Trench Drain Inverts – Sidewall Extensions	7
Z882 Factory Fabrications	7

Z874-12, Z874-18, Z874-21 Pre-sloped Trench Drain System - Polyethylene

Z874-12, Z874-18, Z874-21 H-20/25 – Class C System	8
Z874-12, Z874-18, Z874-21 – Class F System	8
Z874-12, Z874-18, Z874-21 H-20/25 – Class C System	9
Z874-21 H-20/25 – Class C System	9
Z874-12, Z874-18, and Z874-21 Flow Rate Data	10
Z874-U Utility Trench	11
Factory Fabrications	12
Field Fabrications	12
Outlets	12

Catch Basins

Z887 – Polyethylene	13
---------------------	----

Z888-12, Z888-18, Z888-36 Slot Drains - Polyethylene

Z888 H-20/25 – Highway Slot Drain System	14
Z888-PSF – Pre-sloped Slot Drain	14
Z888 H-20/25 – Heel-Proof Non-Removable Ductile Grate	15
Z888 H-20/25 – Heavy-Duty Non-Removable Ductile Iron Frame	15
Z889 – Cleanout Ports	16

Additional Information

Installation Methods	16
Channel Material	17
Standard Outlet Chart	17
System Loading Classifications	18
Literature and Marketing Resources	19
Area Specialists	19
Tech Support	19
Terms and Conditions	20

6" Pre-sloped Trench Drain Polyethylene

Z886-HDD and -HR H-20/25 System

- Load capacity exceeding 50,000 pounds.
- -HDD grate is a one-piece design for highway safety.
- Interlocking grates and channels eliminate lateral stacking of grates.
- Integral locking lugs.
- Made in the USA.

H-20/25 Grate

Material	Ductile Iron
DIN Rating	Class C
Weight	HDD - 7.7 lb. per foot HR - 12.45 lb. per foot
Open Area	HDD - 39.22 sq. in. per foot HR - 30.6 sq. in. per foot
ANSI Rating	Heavy Duty
Applications	Airports, Hangars, Highways

-HDD H-20/25

One-Piece Ductile Grate

-HR H-20/25

Two-Piece Ductile Removable Grate

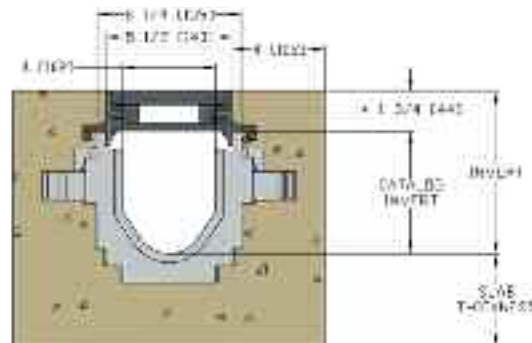
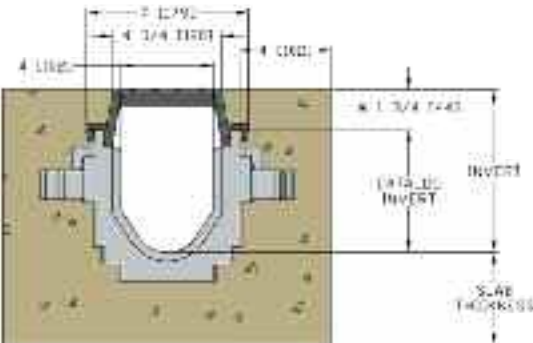

*Inverts vary. See page 4.

*Inverts vary. See page 4.



6" Pre-sloped Trench Drain Polyethylene

Z886-FGF Class F System

- Load capacity exceeding 200,000 pounds.
- Non-corrosive removable grate locking features with no latches, bolts, or springs required.
- Standard ductile iron frame and grate.
- Grate locking procedure eliminates lateral grate shifting.
- Continuous slotted concrete anchoring bars.
- Load bearing area = 45 inch²/foot.

H-20/25 Grate

Material	Ductile Iron
DIN Rating	Class F
Weight	27/20 16.2 lb. per foot
Open Area	21.00 sq. in. per foot
ANSI Rating	Special Duty
Applications	Airports, Hangars, Highways, Ports

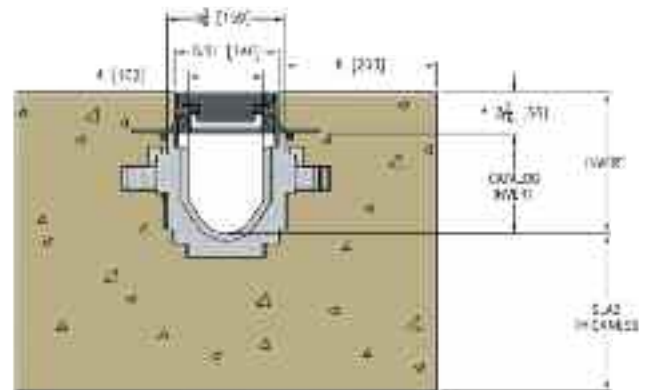
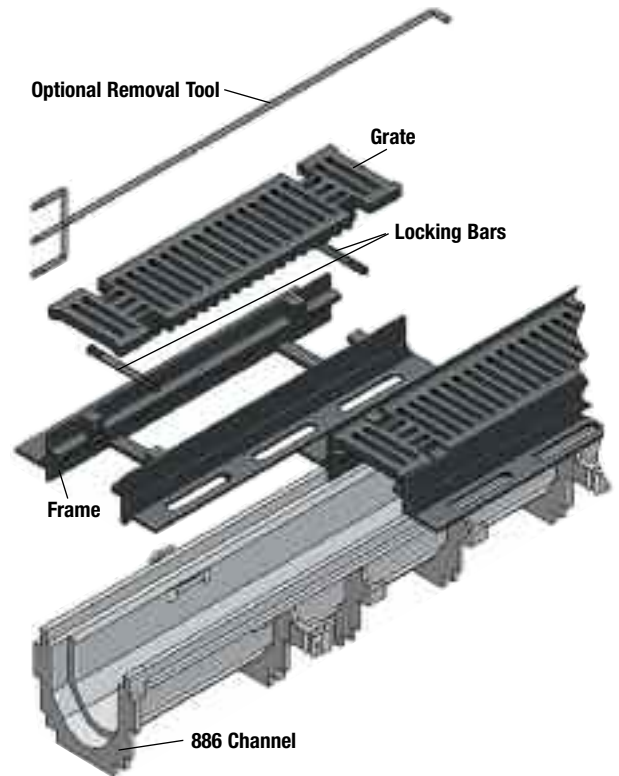

Airport Trench Drain



Airport Trench Drain

Z886 Trench Drain Inverts

Sidewall Extensions

- Sidewalls are factory installed to channels.
- Sidewalls add depth and increase hydraulic capacity.
- Two sets of factory installed sidewalls increase the pre-sloped length of run to a minimum of 300 linear feet.
- Neutral channels may be installed to increase overall run length.

Z886

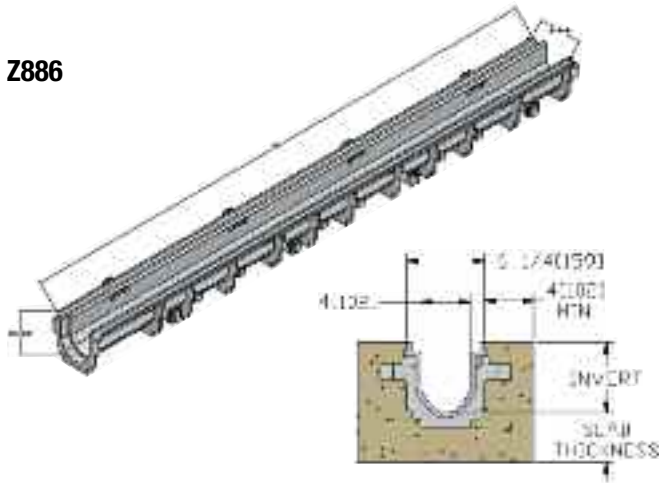

Z886 Single Sidewall

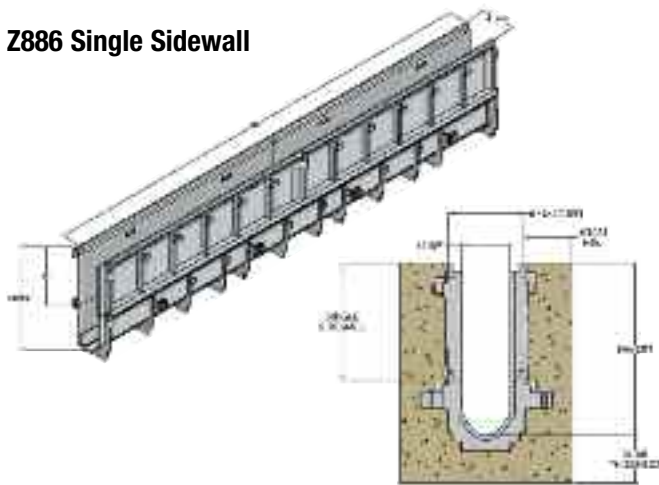

Z886 Double Sidewall

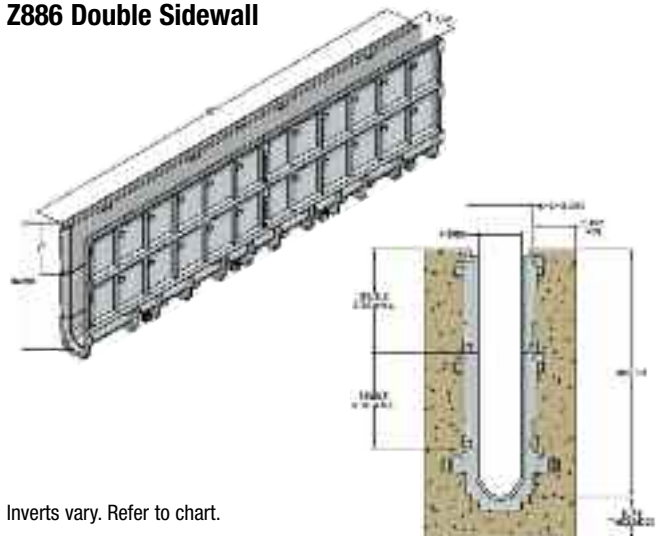

Inverts vary. Refer to chart.

Z886 Flow Rate Data*

Trench Number	Shallow Invert Inches [mm]	Deep Invert Inches [mm]	Flow Rate CFS
8601	3.50 [89]	4.10 [104]	0.207
8602	4.10 [104]	4.70 [119]	0.272
8603	4.70 [119]	5.30 [135]	0.339
8603N	5.30 [135]	5.30 [135]	–
8604	5.30 [135]	5.90 [150]	0.407
8605	5.90 [150]	6.50 [165]	0.476
8606	6.50 [165]	7.10 [180]	0.545
8606N	7.10 [180]	7.10 [180]	–
8607	7.10 [180]	7.70 [196]	0.615
8608	7.70 [196]	8.30 [211]	0.685
8609	8.30 [211]	8.90 [226]	0.756
8610	8.90 [226]	9.50 [241]	0.826
8611	9.50 [241]	10.10 [257]	0.897
8612	10.10 [257]	10.70 [272]	0.968
8612N	10.70 [272]	10.70 [272]	–
8613	10.70 [272]	11.30 [287]	1.039
8614	11.30 [287]	11.90 [302]	1.111
8615	11.90 [302]	12.50 [318]	1.182

Z886-SW (single sidewall)*

Trench Number	Shallow Invert Inches [mm]	Deep Invert Inches [mm]	Flow Rate CFS
8601-SW	12.50 [318]	13.10 [333]	1.253
8602-SW	13.10 [333]	13.70 [348]	1.325
8603-SW	13.70 [348]	14.30 [363]	1.396
8603N-SW	14.30 [363]	14.30 [363]	–
8604-SW	14.30 [363]	14.90 [378]	1.468
8605-SW	14.90 [378]	15.50 [394]	1.540
8606-SW	15.50 [394]	16.10 [409]	1.611
8606N-SW	16.10 [409]	16.10 [409]	–
8607-SW	16.10 [409]	16.70 [424]	1.683
8608-SW	16.70 [424]	17.30 [439]	1.755
8609-SW	17.30 [439]	17.90 [455]	1.826
8610-SW	17.90 [455]	18.50 [470]	1.898
8611-SW	18.50 [470]	19.10 [485]	1.970
8612-SW	19.10 [485]	19.70 [500]	2.042
8612N-SW	19.70 [500]	19.70 [500]	–
8613-SW	19.70 [500]	20.30 [516]	2.114
8614-SW	20.30 [516]	20.90 [531]	2.186
8615-SW	20.90 [531]	21.50 [546]	2.257

Z886-SWx2 (double sidewall)*

Trench Number	Shallow Invert Inches [mm]	Deep Invert Inches [mm]	Flow Rate CFS
8601-SWx2	21.50 [546]	22.10 [561]	2.329
8602-SWx2	22.10 [561]	22.70 [577]	2.401
8603-SWx2	22.70 [577]	23.30 [592]	2.473
8603N-SWx2	23.30 [592]	23.30 [592]	–
8604-SWx2	23.30 [592]	23.90 [607]	2.545
8605-SWx2	23.90 [607]	24.50 [622]	2.617
8606-SWx2	24.50 [622]	25.10 [638]	2.689
8606N-SWx2	25.10 [638]	25.10 [638]	–
8607-SWx2	25.10 [638]	25.70 [653]	2.761
8608-SWx2	25.70 [653]	25.30 [668]	2.833
8609-SWx2	26.30 [668]	26.90 [683]	2.905
8610-SWx2	26.90 [683]	27.50 [699]	2.977
8611-SWx2	27.50 [699]	28.10 [714]	3.049
8612-SWx2	28.10 [714]	28.70 [729]	3.121
8612N-SWx2	28.70 [729]	28.70 [729]	–
8613-SWx2	28.70 [729]	29.30 [744]	3.193
8614-SWx2	29.30 [744]	29.90 [759]	3.265
8615-SWx2	29.90 [759]	30.50 [775]	3.337

*Add 2-3/16" for FGF Grate; add 1-3/4" for HDD/HR Grate.

6" Pre-sloped Trench Drain Polyethylene

Z886 Outlet Fabrication

- Custom factory fabricated outlets for ease of connection to basins.
- Multiple depths and angles available to fit the end of the channel run.
- Jobsite fabrications makes outleting adaptable for onsite alterations.

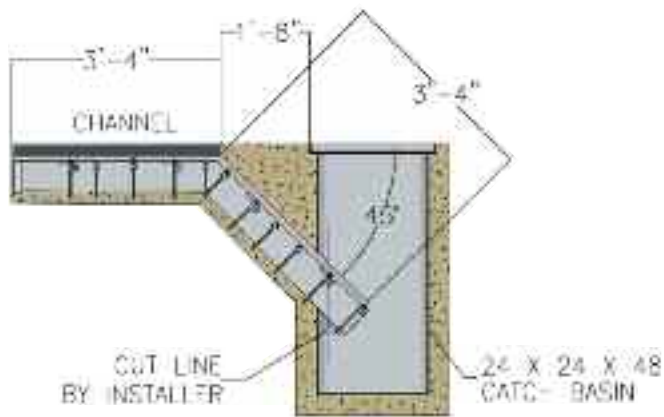

Custom-Made Catch Basin



Roadway Curb

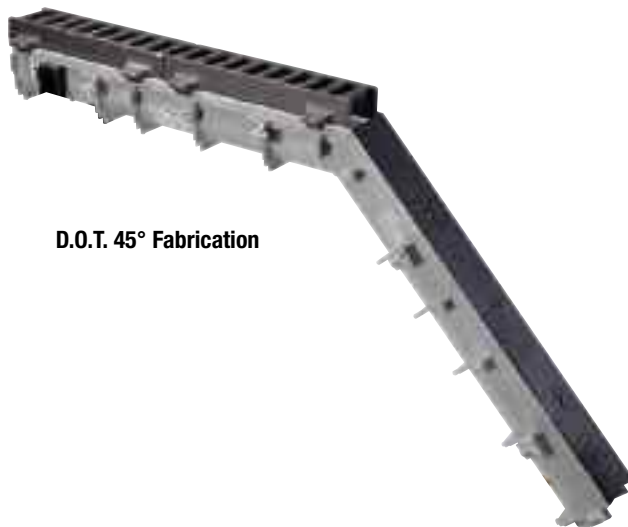

D.O.T. 45° Fabrication



Roadway Curb

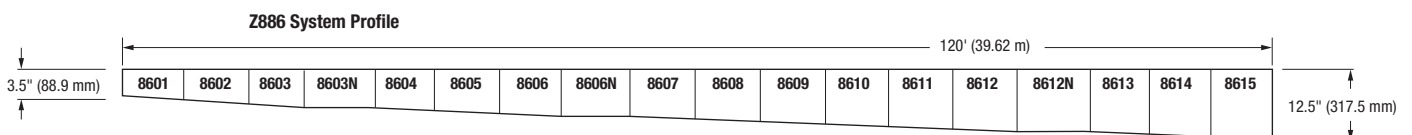

Inverts vary. See chart on page 4.
Available in sloping or non-sloping inverts.

12" Pre-sloped Trench Drain Polyethylene

Z882-DGC

- Heavy dynamic loading exceeding 50,000 lb. H-20/25 load tested.
- Four-corner bolt lockdown create superior concrete bonding.
- Made in U.S.A. per requirements.

DGC Grate

Material	Ductile Iron
DIN Rating	Class C
Weight	42 lbs. (21.00 per ft.)
Open Area	57.5 sq. in. per ft.
ANSI Rating	Extra Heavy Duty
Applications	Vehicle and Truck Maintenance Areas



Z882-DGF

With Ductile Frame and Grate

- Load capacity exceeding 200,000 pounds.
- Four-corner bolt lockdown.
- Standard ductile iron frame and grate.
- Load bearing area = 27 inch²/foot.
- Nelson studs every 24 inches.
- Made in U.S.A. per requirements.

DGF Grate

Material	Ductile Iron
DIN Rating	Class F
Weight	54.00 lbs. (27.00 per ft.)
Open Area	57.00 sq. in. per ft.
ANSI Rating	Special Duty
Applications	De-icing Pads, Hangars, Highways, Ports

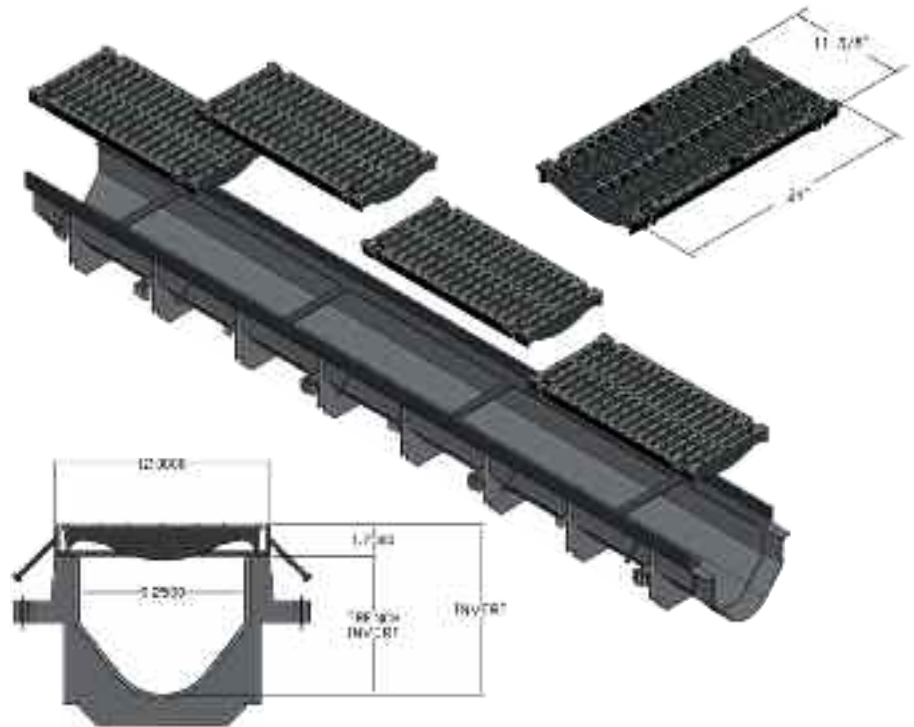

Z882 System Profile

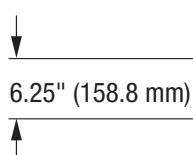

8201	8202	8203	8203N	8204	8205	8206	8206N	8207	8208
------	------	------	-------	------	------	------	-------	------	------

Inverts vary. See chart on page 7.
Available in sloping or non-sloping inverts.

Z882 Trench Drain Inverts

Sidewall Extensions

- Sidewalls are factory installed to channels.
- Sidewalls add depth and increase hydraulic capacity.
- Factory installed sidewalls increase the pre-sloped length of run to a minimum of 300 linear feet.
- Neutral channels may be installed to increase overall run length.

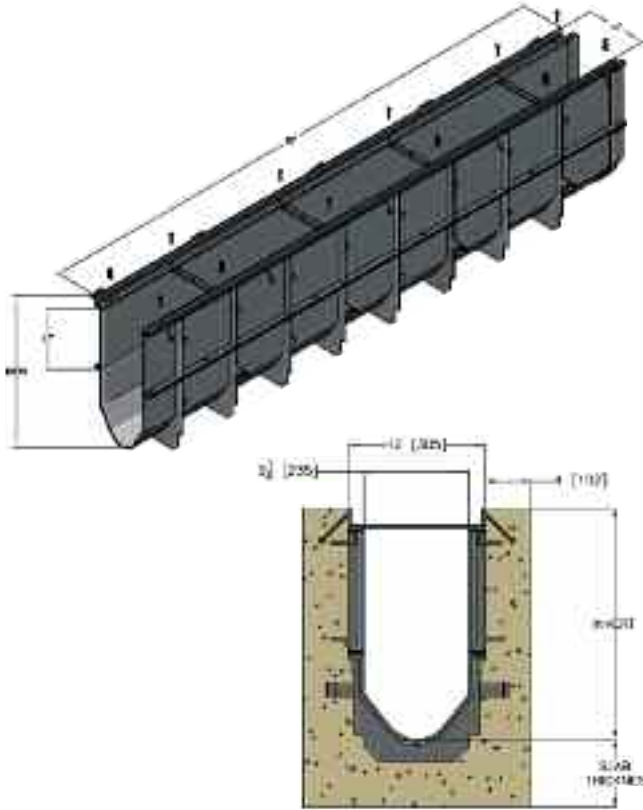

Airport Trench Drain

Z882 Flow Rate Data

Trench Number	Shallow Invert Inches [mm]	Deep Invert Inches [mm]	Flow Rate CFS
8201	6.25 [159]	7.25 [184]	1.240
8202	7.25 [184]	8.25 [210]	1.723
8203	8.25 [210]	9.25 [235]	2.227
8203N	9.25 [235]	9.25 [235]	—
8204	9.25 [235]	10.25 [260]	2.744
8205	10.25 [260]	11.25 [286]	3.272
8206	11.25 [286]	12.25 [311]	3.807
8206N	12.25 [311]	12.25 [311]	—
8207	12.25 [311]	13.25 [337]	4.348
8208	13.25 [337]	14.25 [362]	4.893
8209	14.25 [362]	15.25 [387]	5.443
8209N	15.25 [387]	15.25 [387]	—
8210	15.25 [387]	16.25 [413]	5.995
8211	16.25 [413]	17.25 [438]	6.549
8212	17.25 [438]	18.25 [464]	7.106

Z882 Factory Fabrications

- Multiple depths and angles available to fit the channel run.

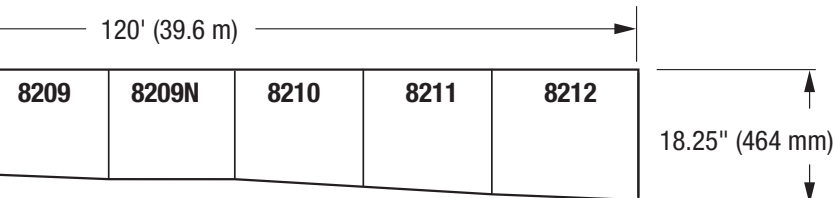
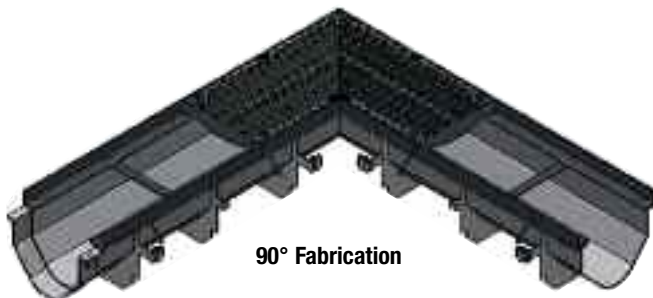

Z882-SW (single sidewall)

Trench Number	Shallow Invert Inches [mm]	Deep Invert Inches [mm]	Flow Rate CFS
8202SW	18.25 [464]	19.25 [489]	7.664
8203SW	19.25 [488]	20.25 [514]	8.224
8203NSW	20.25 [514]	20.25 [514]	—
8204SW	20.25 [514]	21.25 [539]	8.785
8205SW	21.25 [539]	22.25 [565]	9.346
8206SW	22.25 [565]	23.25 [590]	9.910
8206NSW	23.25 [590]	23.25 [590]	—
8207SW	23.25 [590]	24.25 [616]	10.473
8208SW	24.25 [616]	25.25 [641]	11.037
8209SW	25.25 [641]	26.25 [666]	11.603
8209NSW	26.25 [666]	26.25 [666]	—
8210SW	26.25 [666]	27.25 [692]	12.169
8211SW	27.25 [692]	28.25 [717]	12.735
8212SW	28.25 [717]	29.25 [743]	13.303

Z874-12, -18, -21 Pre-sloped Trench Drain System Polyethylene

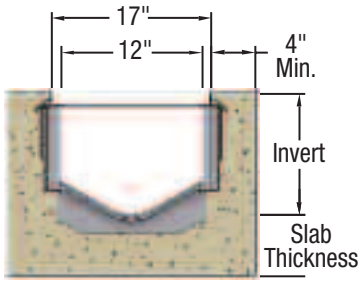

Z874-12

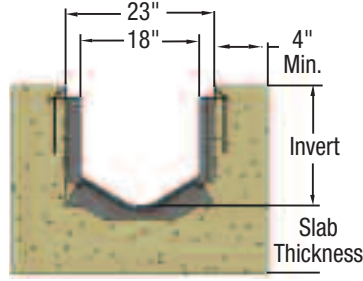

Z874-18

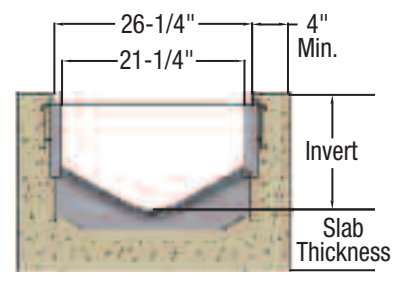

Z874-21

Z874 H-20/25 Class C System

- Heavy dynamic loading exceeding 50,000 lb. H-20/25 load tested.
- Made in U.S.A. per requirements.

DGC Grate on –	Z874-12	Z874-18	Z874-21
Material	Ductile Iron	Ductile Iron	Ductile Iron
DIN Rating	Class C	Class C	Class C
Weight	27 lbs.	89.8 lbs.	54 lbs.
Length	20 in.	20 in.	20 in.
Width	16.25 in.	22.25 in.	25.5 in.
Open Area	118 sq. in./lin. ft.	112 sq. in./lin. ft.	133 sq. in./lin. ft.
H-20/25 Rated	Yes	Yes	Yes
FAA Rated	No	No	No
Applications	Highways, Parking Lots, Airports		



Airport Trench Drain



Port Trench Drain

Z874 H-20/25 Class F System

- Load capacity exceeding 200,000 pounds.
- Four-bolt lockdown.
- Standard ductile iron frame and grate.
- Load bearing area = 45 inch²/foot.
- Made in U.S.A. per requirements.

DGF Grate on –	Z874-12	Z874-18	Z874-21
Material	Ductile Iron	Ductile Iron	Ductile Iron
DIN Rating	Class F	Class F	Class F
Weight	49 lbs.	128 lbs.	130 lbs.
Length	20 in.	20 in.	20 in.
Width	16.25 in.	22.25 in.	25.5 in.
Open Area	90 sq. in./lin. ft.	94 sq. in./lin. ft.	112 sq. in./lin. ft.
H-20/25 Rated	Yes	Yes	Yes
FAA Rated	Yes	Yes	Yes
Applications	Ports, Airports, Highways		

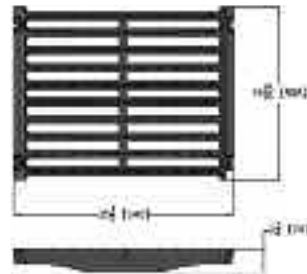

Z874-DGC

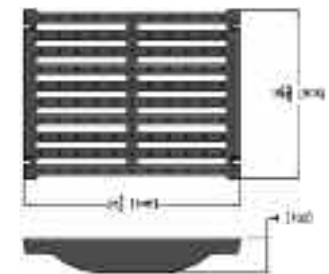

Z874-DGF

Z874-21 System Profile

11.2488	2101P	2102P	2103P	2104P	2105P	2105NP	2106P	2107P	2108P	2109P	2110P
---------	-------	-------	-------	-------	-------	--------	-------	-------	-------	-------	-------

Inverts vary. See chart on page 10.
Available in sloping or non-sloping inverts.

Z874 H-20/25 Class C System

ADA/Heel-Proof Compliant

- Heavy dynamic loading exceeding 50,000 lb. H-20/25 load tested.
- Four-corner bolt lockdown.
- Made in U.S.A. per requirements.

HPD Grate on –	Z874-12	Z874-18	Z874-21
Material	Ductile Iron	Ductile Iron	Ductile Iron
DIN Rating	Class C	Class C	Class C
Weight	47.5 lbs.	92.5 lbs.	94 lbs.
Length	20 in.	20 in.	20 in.
Width	16.25 in.	22.25 in.	25.5 in.
Open Area	37 sq. in./lin. ft.	26.3 sq. in./lin. ft.	51 sq. in./lin. ft.
H-20/25 Rated	Yes	Yes	Yes
FAA Rated	No	No	No
Applications	Highways, Parking Lots, Airports		



Highway – Z874-FL DOT Grate

Z874-21 H-20/25 Class C System

Inverted Grate

- Heavy dynamic loading exceeding 50,000 lb. H-20/25 load tested.
- Four-bolt lockdown.
- Load bearing area = 54 inch²/foot.

FL DOT Grate on – Z874-21

Material	Ductile Iron
DIN Rating	Class C
Weight	75 lbs.
Length	20 in.
Width	25.5 in.
Open Area	117 sq. in./lin. ft.
H-20/25 Rated	Yes
FAA Rated	No
Applications	Highways, Parking Lots, Airports

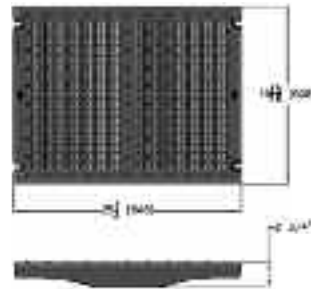

Z874-HPD Grate

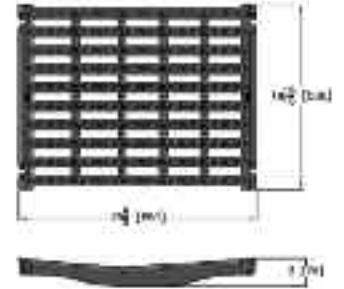

Z874-FL-DOT Grate



Port

220'

2111P	2112P	2113P	2114P	2115P	2115NP	2116P	2117P	2118P	2119P	2120P	2121P	2122P	2123P	2124P	2125P	2125NP	2126P	2127P	2128P	2129P	2130P	36.2100
-------	-------	-------	-------	-------	--------	-------	-------	-------	-------	-------	-------	-------	-------	-------	-------	--------	-------	-------	-------	-------	-------	---------

Z874-12, -18, -21 Pre-sloped Trench Drain System Polyethylene

Z874-12 Flow Rate Data				Z874-18 Flow Rate Data				Z874-21 Flow Rate Data			
Trench Number	Shallow Invert In. [mm]	Deep Invert In. [mm]	Flow Rate CFS	Trench Number	Shallow Invert In. [mm]	Deep Invert In. [mm]	Flow Rate CFS	Trench Number	Shallow Invert In. [mm]	Deep Invert In. [mm]	Flow Rate CFS
1201P	9.25 [235]	10.08 [256]	3.306	1801P	10.25 [260]	11.08 [281]	6.850	2101P	11.25 [286]	12.08 [307]	8.369
1202P	10.08 [256]	10.91 [277]	3.941	1802P	11.08 [281]	11.91 [303]	8.040	2102P	12.08 [305]	12.91 [328]	9.857
1203P	10.91 [277]	11.75 [298]	4.589	1803P	11.91 [303]	12.75 [324]	9.260	2103P	12.91 [328]	13.75 [349]	11.388
1204P	11.75 [298]	12.58 [319]	5.248	1804P	12.75 [324]	13.58 [345]	10.500	2104P	13.75 [349]	14.58 [370]	12.953
1205P	12.58 [319]	13.41 [341]	5.915	1805P	13.58 [345]	14.41 [366]	11.760	2105P	14.58 [370]	15.41 [391]	14.549
1205NP	13.41 [341]	13.41 [341]	-	1805NP	14.41 [366]	14.41 [366]	-	2105NP	15.41 [391]	15.41 [391]	-
1206P	13.41 [341]	14.24 [362]	6.589	1806P	14.41 [366]	15.24 [387]	13.040	2106P	15.41 [391]	16.42 [417]	16.170
1207P	14.24 [362]	15.07 [383]	7.268	1807P	15.24 [387]	16.07 [408]	14.330	2107P	16.42 [417]	17.07 [434]	17.814
1208P	15.07 [383]	15.91 [404]	7.953	1808P	16.07 [408]	16.91 [429]	15.630	2108P	17.07 [434]	17.91 [455]	19.478
1209P	15.91 [404]	16.74 [425]	8.641	1809P	16.91 [429]	17.74 [451]	16.940	2109P	17.91 [455]	18.74 [476]	21.159
1210P	16.74 [425]	17.57 [446]	9.333	1810P	17.74 [451]	18.57 [472]	18.270	2110P	18.74 [476]	19.57 [497]	22.855
1211P	17.57 [446]	18.40 [467]	10.028	1811P	18.57 [472]	19.40 [493]	19.600	2111P	19.57 [497]	20.40 [518]	24.565
1212P	18.40 [467]	19.23 [489]	10.726	1812P	19.40 [493]	20.23 [514]	20.930	2112P	20.40 [518]	21.23 [539]	26.287
1213P	19.23 [489]	20.07 [510]	11.426	1813P	20.23 [514]	21.07 [535]	22.280	2113P	21.23 [539]	22.07 [560]	28.020
1214P	20.07 [510]	20.90 [531]	12.128	1814P	21.07 [535]	21.90 [556]	23.630	2114P	22.07 [560]	22.90 [582]	29.763
1215P	20.90 [531]	21.73 [552]	12.832	1815P	21.90 [556]	22.73 [577]	24.980	2115P	22.90 [582]	23.73 [603]	31.514
1215NP	21.73 [552]	21.73 [552]	-	1815NP	22.73 [577]	22.73 [577]	-	2115NP	23.73 [603]	23.73 [603]	-
1216P	21.73 [552]	22.56 [573]	13.538	1816P	22.73 [577]	23.56 [598]	26.340	2116P	23.73 [603]	24.56 [624]	33.274
1217P	22.56 [573]	23.39 [594]	14.244	1817P	23.56 [598]	24.39 [620]	27.710	2117P	24.56 [624]	25.39 [645]	35.041
1218P	23.39 [594]	24.23 [615]	14.953	1818P	24.39 [620]	25.23 [641]	29.080	2118P	25.39 [645]	26.23 [666]	36.814
1219P	24.23 [615]	25.06 [636]	15.662	1819P	25.23 [641]	26.07 [663]	30.450	2119P	26.23 [666]	27.06 [687]	38.594
1220P	25.06 [636]	25.89 [658]	16.372	1820P	26.07 [663]	26.89 [683]	31.820	2120P	27.06 [687]	27.89 [701]	40.379
1221P	25.89 [658]	26.72 [679]	17.084	1821P	26.89 [683]	27.72 [704]	33.200	2121P	27.89 [701]	28.72 [729]	42.169
1222P	26.72 [679]	27.55 [700]	17.796	1822P	27.72 [704]	28.55 [725]	34.580	2122P	28.72 [729]	29.55 [751]	43.964
1223P	27.55 [700]	28.39 [721]	18.509	1823P	28.55 [725]	29.39 [746]	35.960	2123P	29.55 [751]	30.39 [772]	45.763
1224P	28.39 [721]	29.22 [742]	19.223	1824P	29.39 [746]	30.22 [768]	37.350	2124P	30.39 [772]	31.22 [793]	47.567
1225P	29.22 [742]	30.05 [763]	19.937	1825P	30.22 [768]	31.05 [789]	38.740	2125P	31.22 [793]	32.05 [814]	49.374
1225NP	30.05 [763]	30.05 [763]	-	1825NP	31.05 [789]	31.05 [789]	-	2125NP	32.05 [814]	32.05 [814]	-
1226P	30.05 [763]	30.88 [784]	20.652	1826P	31.05 [789]	31.89 [810]	40.120	2126P	32.05 [814]	32.88 [835]	51.184
1227P	30.88 [784]	31.71 [806]	21.367	1827P	31.89 [810]	32.71 [831]	41.520	2127P	32.88 [835]	33.71 [856]	52.998
1228P	31.71 [806]	32.55 [827]	22.083	1828P	32.71 [831]	33.55 [852]	42.910	2128P	33.71 [856]	34.55 [878]	54.815
1229P	32.55 [827]	33.38 [848]	22.800	1829P	33.55 [852]	34.38 [873]	44.300	2129P	34.55 [878]	35.38 [899]	56.634
1230P	33.38 [848]	34.21 [869]	23.517	1830P	34.38 [873]	35.21 [894]	45.700	2130P	35.38 [899]	36.21 [920]	58.457



Median Trench Drain



Airport Trench Drain

Z874-U Utility Trench Polyethylene

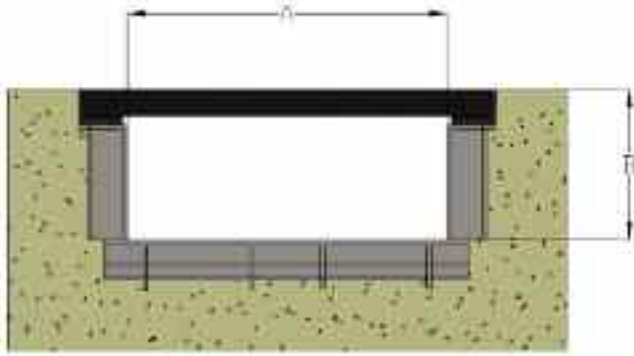

Utility trench can be customized to engineer designs.

Z874-U Features

- UL-94 rated
- Dielectric channels
- Layout drawings provided
- Flexible installations: suspended, rebar clip, bedding

Z874-U-DCC

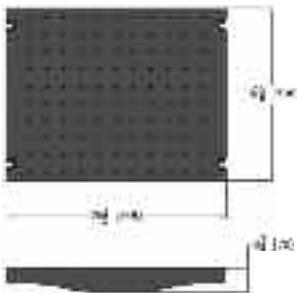

DCC Grate on –	Z874-12	Z874-18	Z874-21
Material	Ductile Iron	Ductile Iron	Ductile Iron
DIN Rating	Class C	Class C	Class C
Weight	29 lbs. per ft.	56.5 lbs. per ft.	58 lbs. per ft.
Open Area	NA	NA	NA
ANSI Rating	Heavy Duty	Heavy Duty	Heavy Duty
H-20/25 Rated	Yes	Yes	Yes
FAA Rated	No	No	No
Applications	Toll Plazas, Hangars		



Z874-U Heavy Duty/Class C

Z874-U-HD System Chart

Heavy/Special Duty Systems			
Size	A - Throat Width Inches [mm]	B - Max. Depth Inches [mm]	X - Length Inches [mm]
Z874-9-U	9.25 [235]	22 [559]	96 [2438]
Z874-12-U	12 [305]	30 [762]	80 [2032]
Z874-18-U	18 [457]	30 [762]	80 [2032]
Z874-21-U	21 [533]	30 [762]	80 [2032]

Z874-U Options

- Non-skid surface
- Dielectric grating
- Fabrication capabilities
- Can be job-site sealed watertight
- Separation of chambers within the trench
- On-site fabrication welding

Z874-U-DCF

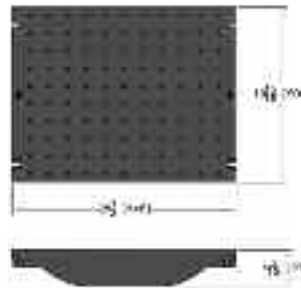

DCF Grate on –	Z874-12	Z874-18	Z874-21
Material	Ductile Iron	Ductile Iron	Ductile Iron
DIN Rating	Class F	Class F	Class F
Weight	55 lbs. per ft.	82 lbs. per ft.	95 lbs. per ft.
Open Area	NA	NA	NA
ANSI Rating	Special Duty	Special Duty	Special Duty
H-20/25 Rated	Yes	Yes	Yes
FAA Rated	Yes	Yes	Yes
Applications	Toll Plazas, Hangars		

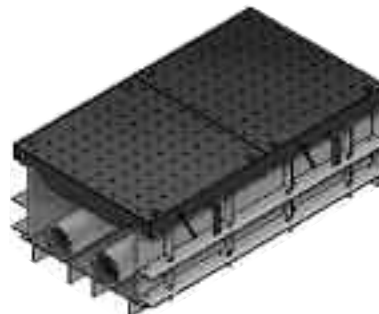

Z874-U Special Duty/Class F

Flo-Thru Trench Drains

Factory Fabrications

- Precise fabrications
- Made to order
- Very versatile



Field Fabrications

- Ease of use
- Easy to cut with standard tools
- Easy to weld



Outlets



End Outlets

- E__ = size of end outlet
- No-hub connections
- Many sizes available

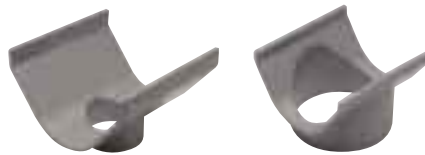

Bottom Outlets

- U__ = size of bottom outlet
- No-hub connections
- Many sizes available



Side Outlet

- S__ = size of side outlet
- No-hub connections
- Many sizes available

Note: For specific systems and sizes, see outlet chart on page 17.

Z887 Catch Basins Polyethylene

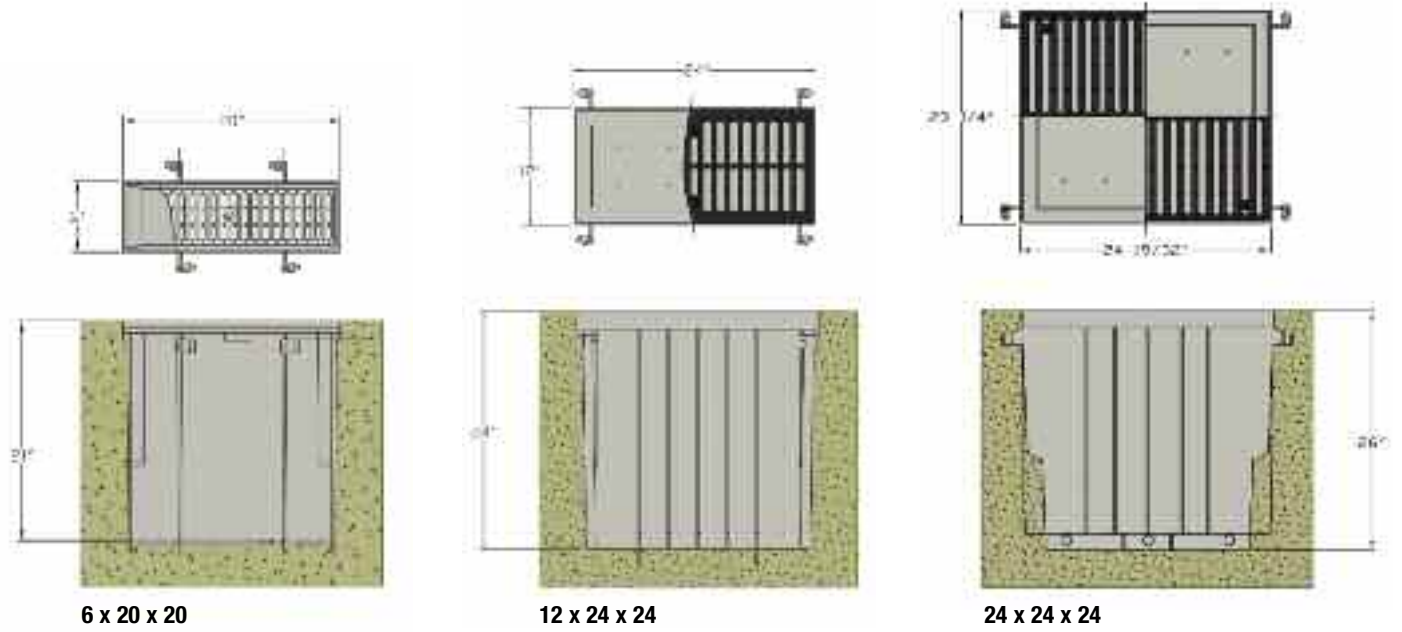

Z887 Catch Basins

- Use same grate as trench system
- Custom depths available

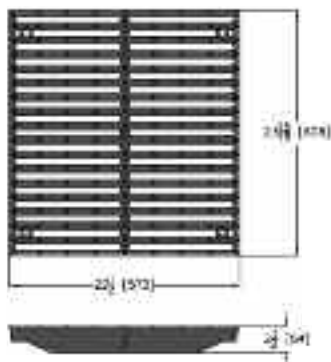
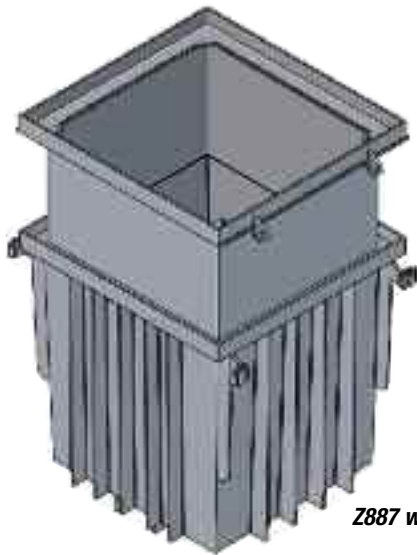

Z887-DGC

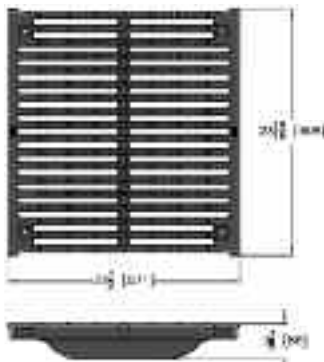

Z887-DGF

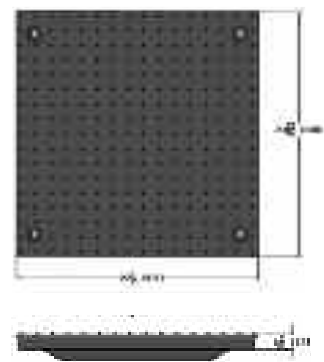

Z887-DCF

Z888-12, -18, -36 Slot Drain - Polyethylene

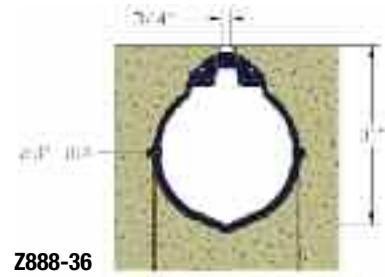
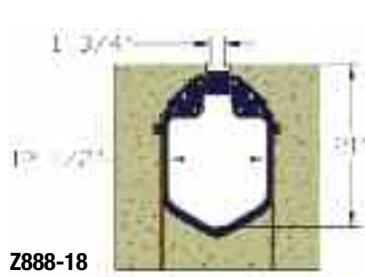
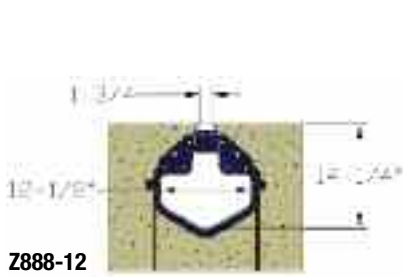

Z888 H-20/25

Class C System
Highway Slot Drain System

- 1-3/4" surface interface.

Zurn recommends cleanout ports be installed on high and low ends of runs.

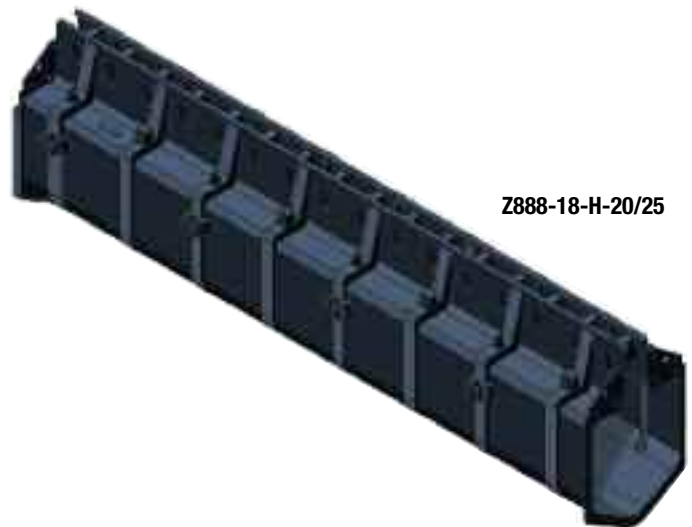

Open Channel	Z888-12	Z888-18	Z888-36
Material	Linear Low Density Polyethylene		
DIN Rating	Class C	Class C	Class C
Weight	37 lbs.	50 lbs.	68 lbs.
Length	80 in.	80 in.	80 in.
Width	1.75 in.	1.75 in.	1.75 in.
Open Area	140 sq. in.	140 sq. in.	140 sq. in.
H-20/25 Rated	Yes	Yes	Yes
FAA Rated	No	No	No
Applications	Highways, Parking Lots, Ports		

Z888-PSF

Pre-sloped Slot Drain

- Custom slopes to meet site needs.

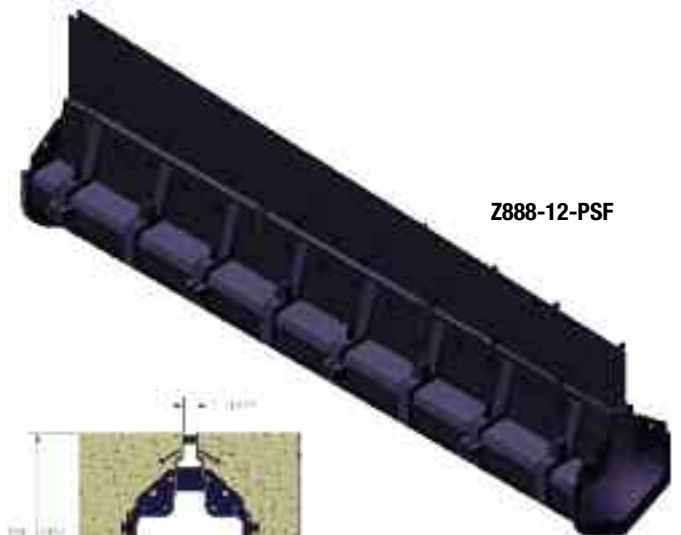

PSF Grate on –	Z888-12	Z888-18	Z888-36
Material	"E" Coated Steel*	"E" Coated Steel*	"E" Coated Steel*
DIN Rating	Class E	Class E	Class E
Weight	Varies	Varies	Varies
Length	80 in.	80 in.	80 in.
Width	1.75 in.	1.75 in.	1.75 in.
Open Area	140 sq. in.	140 sq. in.	140 sq. in.
H-20/25 Rated	Yes	Yes	Yes
FAA Rated	Yes	Yes	Yes
Applications	Airports, Highways, Parking Lots, Ports		

*E-Coating is a system that uses chemical solutions and electricity to administer a protective coating to electrically conductive objects.

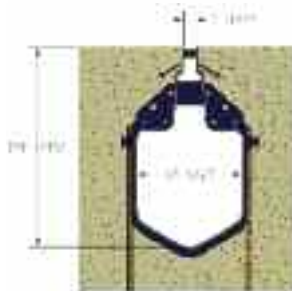

Z888-12, -18, -36 Slot Drain - Polyethylene

Z888 H-20/25

Class E System
Heel-Proof Non-Removable
Ductile Grate

- ADA/heel-proof compliant.



HPD Grate on –	Z888-12	Z888-18	Z888-36
Material	Ductile Iron	Ductile Iron	Ductile Iron
DIN Rating	Class E*	Class E*	Class E*
Weight	32 lbs.	32 lbs.	32 lbs.
Length	40 in.	40 in.	40 in.
Width	5 in.	5 in.	5 in.
Open Area	6.64 sq. in. per ft.	6.64 sq. in. per ft.	6.64 sq. in. per ft.
H-20/25 Rated	Yes	Yes	Yes
FAA Rated	Yes*	Yes*	Yes*
Applications	Airports, Highways		

*Additional rebar reinforcement required.

Z888 H-20/25

Class E System
Heavy-Duty Non-Removable
Ductile Iron Frame

- Complete with anchor studs to handle dynamic loads.



HD Grate on –	Z888-12	Z888-18	Z888-36
Material	Ductile Iron	Ductile Iron	Ductile Iron
DIN Rating	Class E*	Class E*	Class E*
Weight	29 lbs.	29 lbs.	29 lbs.
Length	40 in.	40 in.	40 in.
Width	5 in.	5 in.	5 in.
Open Area	20.44 sq. in. per ft.	20.44 sq. in. per ft.	20.44 sq. in. per ft.
H-20/25 Rated	Yes	Yes	Yes
FAA Rated	Yes*	Yes*	Yes*
Applications	Airports, Highways		

*Additional rebar reinforcement required.

Z888-18-HPD

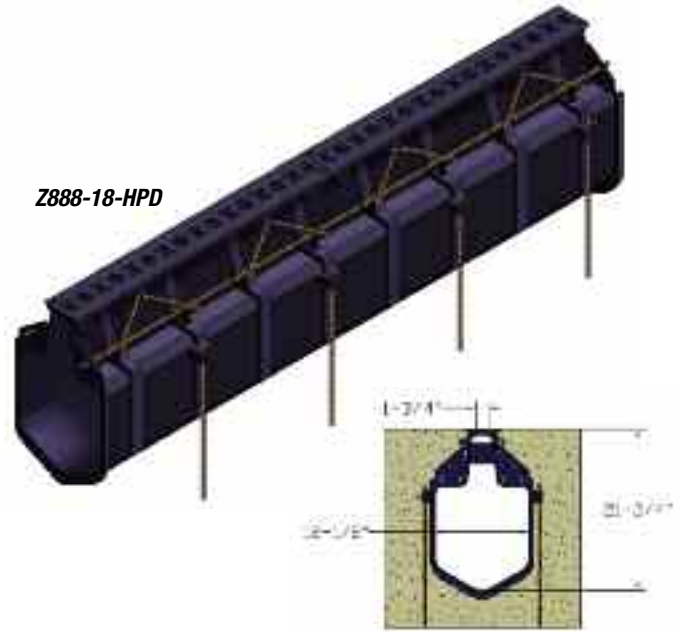

Z888-18-DYN-HD

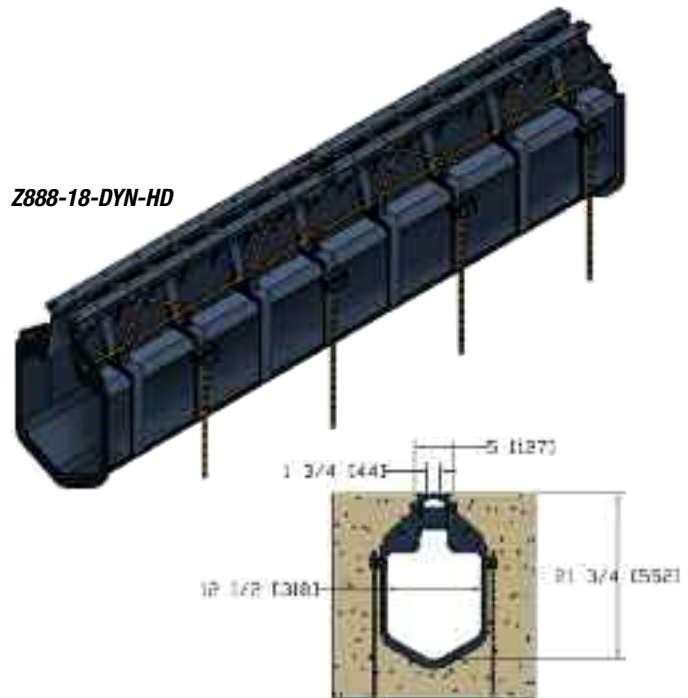

Z888 System Chart

Product Size	Flow Rates @ Grades				Storage Capacity (gpf)
	Laid Flat (cfs)	.3% Slope (cfs)	.6% Slope (cfs)	1% Slope (cfs)	
888-12	0.65	1.13	1.59	2.06	3.609
888-18	2.18	3.78	5.34	6.90	9.2475
888-36	7.59	13.15	18.59	24.00	23.238

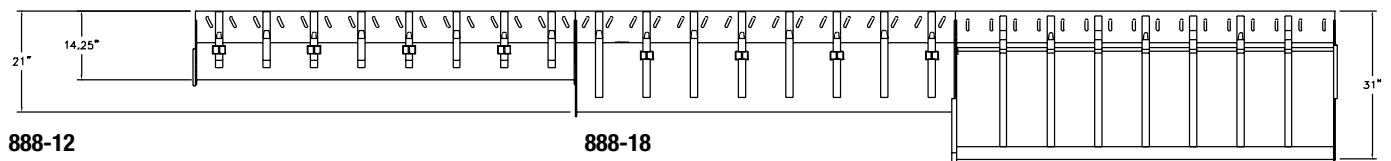

888-12

888-18

888-36

Note: Stair-step method requires transition coupling.

Z889 Cleanout Ports

- Slot drain access points
- In-line with trench
- Same grate options as trench



Z889-12



Z889-18



Z889-36

Installations Suspended, Rebar Clip, and Bedding Methods

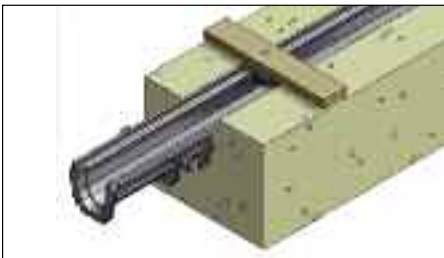

Suspended Installation

Suspended installation is best used where an existing concrete slab or other hard surface such as form board can be used to suspend and hold channel sections.

Use 2" x 4" boards of sufficient length to span the trench and 3" long bolts with nuts and washers to secure channel to boards. Position each channel section end-to-end ensuring a tight, well aligned assembly.

With channel run properly positioned, secure boards in place to avoid any movement such as rising. Place and consolidate concrete under and alongside channels, then finish to the proper grade.

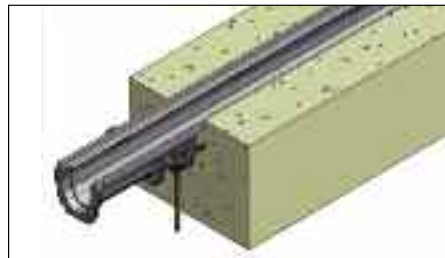

Rebar Clip Installation

Prepare each trench excavation and pull stringline to proper elevation. Place channels alongside the trench in proper numerical sequence. Attach rebar clips to the trench and drive rebar stakes into the sub-grade at required locations. Level trench to desired elevation and lock in place with thumbscrews.



Bedding Installation

Prepare trench excavation. Place channels alongside the trench in proper numerical order. Pour a layer of concrete for the channel to set on. While the concrete is wet, place the channels in the trench. Level trench to desired elevation and let the first layer of concrete set. This will secure the trench in the desired location preventing movement during the second pour. Place and consolidate concrete under and alongside channels, then finish to the proper grade. Use a trowel for a smooth finish.

Rebar Clips



Note: Installation notes are included on all shop drawings.

Flo-Thru Trench Drains

Features	Z886	Z882	Z874-12	Z874-18	Z874-21	Z888-12	Z888-18
Channel Material	Polyethylene	Polyethylene	Polyethylene	Polyethylene	Polyethylene	Polyethylene	Polyethylene
Frame Material	Ductile/Cast	Steel/Ductile	Steel/Ductile	Steel/Ductile	Steel/Ductile	N/A	N/A
Channel Length	80"	96"	80"	80"	80"	80"	80"
Interior Width	4"	9-1/4"	12"	18"	21"	12.5"	12.5"
Overall Exterior Width	6.25"	12"	17"	23"	26.25"	16.5"	16.5"
Starting Invert	3.50"	6.25"	9.25"	10.25"	11.25"	14.25"	21"
Ending Invert (prior to sidewalls)	12.50"	18.25"	34.21"	35.21"	36.21"	14.25"	21"
Single Sidewalls (height) max. invert	(9) 21.5"	(11) 29.25"	(29.75) 63.96"	(29.75) 64.96"	(29.75) 65.96"	N/A	N/A
Double Sidewalls (height) max. invert	(18) 30.5"	(22) 40.25"	N/A	N/A	N/A	N/A	N/A
Channel Weight	21 lbs. avg.	70 lbs. avg.	44 lbs. avg.	60 lbs. avg.	76 lbs. avg.	37 lbs. avg.	50 lbs. avg.
With Single Sidewalls	33 lbs. avg.	96 lbs. avg.	N/A	N/A	N/A	N/A	N/A
With Double Sidewalls	45 lbs. avg.	122 lbs. avg.	N/A	N/A	N/A	N/A	N/A
% of Slope Built-in	0.75%	1.04%	1%	1%	1%	0%	0%
Maximum Sloped Length	300'	288'	400'	400'	400'	Variable	Variable
Neutral Channels	3 sections	3 sections	All Available	All Available	All Available	Standard	Standard
Channel Connection	Interlocking	Interlocking	Interlocking	Interlocking	Interlocking	Interlocking	Interlocking
Installation Clips	Built-in	Built-in	Attachable	Attachable	Attachable	Attachable	Attachable
Field Fabrication	Yes	Yes	Yes	Yes	Yes	Yes	Yes
Factory Fabrication	Yes	Yes	Yes	Yes	Yes	Yes	Yes
Outlets	End/Bottom	End/Bottom	End/Bottom	End/Bottom	End/Bottom	End/Bottom	End/Bottom











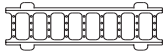
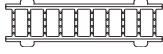



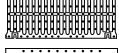

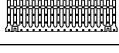
Flo-Thru Standard Outlets

Trench Drain System	End Outlets (Diameter in Inches)								Bottom Outlets (Diameter in Inches)							
	E2	E3	E4	E6	E8	E12	E18	E24	U2	U3	U4	U6	U8	U12	U18	U24
Z886	X	X	X	X					X	X	X	X				
Z882			X	X	X						X	X	X			
Z874-12			X	X	X						X	X	X			
Z874-18			X	X	X	X					X	X	X	X		
Z874-21			X	X	X	X	X				X	X	X	X	X	
Z888-12			X	X	X	X					X	X	X	X		
Z888-18			X	X	X	X	X				X	X	X	X	X	
Z888-36			X	X	X	X	X	X			X	X	X	X	X	X
Z887 - 6 x 20	X	X	X						X	X	X					
Z887 - 12 x 24	X	X	X						X	X	X					
Z887 - 24 x 24	X	X	X	X	X				X	X	X	X	X			

End Outlet: Piping outlet that goes off the end of the trench.

Bottom Outlet: Piping outlet that goes off the bottom of the trench.

Flo-Thru System Loading Classifications

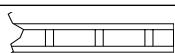
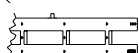
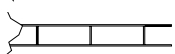
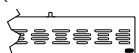
Systems	Grates	H-20/25	C	D	FAA	E	F	
Z886	-HDD (pg. 2)		X					
	-HR (pg. 2)		X					
	-HD-HPD		X	X	X	X	X	
	-HD-BG		X	X	X	X	X	
	-FGF (pg. 3)		X	X	X	X	X	X
Z882	-DGC (pg. 6)		X	X				
	-DGE		X	X	X	X	X	
	-HPD		X	X	X	X		
	-DGF (pg. 6)		X	X	X	X	X	X
Z874-12	-DGC (pg. 8)		X	X				
	-HPD (pg. 9)		X	X	X	X	X	
	-DGF (pg. 8)		X	X	X	X	X	X
Z874-18	-DGC (pg. 8)		X	X				
	-HPD (pg. 9)		X	X	X	X	X	
	-DGF (pg. 8)		X	X	X	X	X	X
Z874-21	-DGC (pg. 8)		X	X				
	-HPD (pg. 9)		X	X	X	X	X	
	-DGF (pg. 8)		X	X	X	X	X	X
Z888-12 Z888-18 Z888-36	STD (pg. 14)		X					
	DYN (pg. 15)		X	X	X	X	X	
	PSF (pg. 14)		X	X	X	X	X	X
	HPD (pg. 15)		X	X	X	X	X	
Test Platen Size	Platen = width of channel x 20" long							

Loading Class	AASHTO H-20/25 loading is defined as	DIN Class C Loading	DIN Class D Loading	FAA Advisory Circular AC	DIN Class E Loading	DIN Class F Loading
Total Load	16,000 lbs. over 8 x 20 footprint	56,200 lbs. [250kN]	89,920 lbs. [400kN]	100,000 lbs. over 9" x 9"	134,800 lbs. [600kN]	202,320 lbs. [900kN]
Load psi 4" Throat		1,873 psi	2,997 psi		4,493 psi	6,744 psi
Load psi 9-1/4" to 12" Throat		936 psi	1,498 psi		2,246 psi	3,372 psi
Load psi over 12" Throat		936 psi	1,498 psi		2,246 psi	3,372 psi

Flo-Thru Literature and Marketing Resources



Architectural



Commercial/Industrial



Athletic Facilities

Area Specialists

- Presentations and Box Lunches
- On-Site Installation Assistance

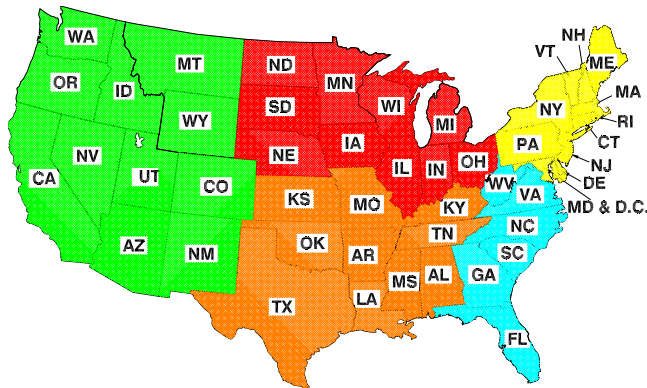

Tech Support

- CAD Layouts
- Submittals
- System Sizing
- Flow Rate CD

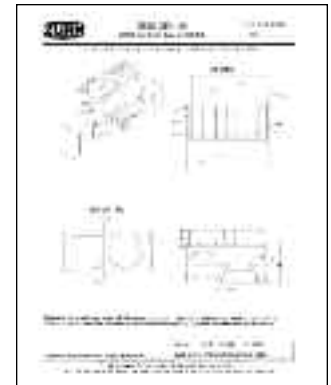
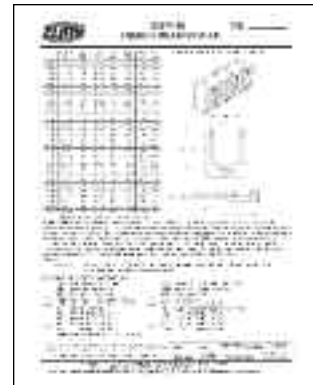
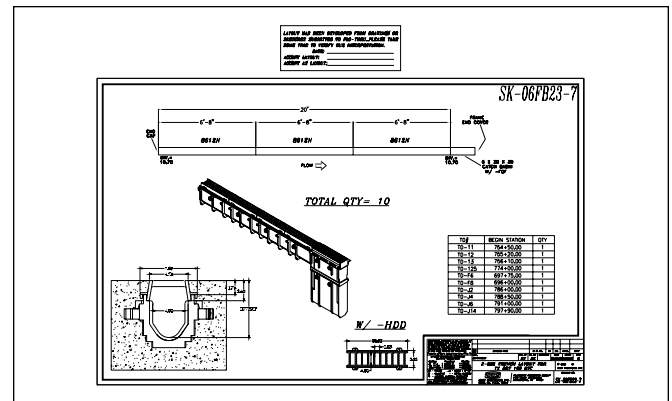

Terms and Conditions Zurn Flo-Thru

Price and Terms of Payment

Prices are F.O.B. Seller's plant, Falconer, New York, or Service Center, 2% cash discount payable 30 days from date of invoice, net 31 days. Interest chargeable at the maximum legal rate on past due items still unpaid after 31 days from date of invoice. In addition to the prices and freight specified, Buyer shall pay all sales, consumers, or other applicable taxes. Minimum invoice \$25.00. All prices subject to change at any time without notice.

Shipment and Delivery

Unless otherwise specifically stated, materials will be shipped freight collect, and all freight is to be paid by the Buyer, but Seller reserves the option to prepay the freight. Buyer agrees to make all complaints for damage in transit or "short count" directly to the carrier; before the contents are unloaded to have the carrier agent's acknowledgement of such damage noted on the bill of lading; and to present to the carrier its agent's acknowledgement of such damaged material with formal claim covering said damage. Shipping dates are estimates and time of delivery is not the essence of this sale of the contract therefor. Under no circumstances will the Seller have any responsibility on account of any delays in manufacture, transportation, or otherwise. Freight prepaid policy is \$5,000.

Limited Warranty

All goods sold hereunder are warranted to be free from defects in material and factory workmanship for a period of one year from the date of purchase. We will replace at no cost goods that prove defective provided we are notified in writing of such defect and the goods are returned to us prepaid at Falconer, New York, with evidence that they have been properly maintained and used in accordance with instructions. WE SHALL NOT BE RESPONSIBLE FOR ANY LABOR CHARGES OR ANY LOSS, INJURY, OR DAMAGES WHATSOEVER, INCLUDING INCIDENTAL OR CONSEQUENTIAL DAMAGES. The sole and exclusive remedy shall be limited to the replacement of the defective goods. Before installation and use, the purchaser shall determine the suitability of the product for his intended use and the purchaser assumes all risk and liability whatever in connection therewith. Where permitted by law, THE IMPLIED

WARRANTY OF MERCHANTABILITY IS EXPRESSLY EXCLUDED. If the products sold hereunder are "consumer products," THE IMPLIED WARRANTY OF MERCHANTABILITY IS LIMITED TO A PERIOD OF ONE YEAR AND SHALL BE LIMITED SOLELY TO THE REPLACEMENT OF THE DEFECTIVE GOODS. All weights stated in our catalogs and lists are approximate and are not guaranteed.

Returned Goods

Standard cataloged material may be returned only with written permission of Seller. Approval will only be granted when material is currently manufactured and listed in the Flo-Thru Price Guide, January 2007, Form No. FT776. Returned goods are subject to a 25% restocking charge plus cost of reconditioning, if necessary, to make material salable. Transportation charges must be prepaid by the Buyer. Credit allowance will be in the form of merchandise credit only – not cash credit. The value of a return must total at least \$100.00 to qualify for credit allowance. Galvanized material will be credited at value of Dura-Coated cast iron, and chrome plated at value of bronze. No credit will be allowed for parts unless originally ordered and invoiced as parts. No credit will be allowed for auxiliary tappings, discontinued, or made-to-order items. The letter B in parentheses (B) following an item on the acknowledgement of a purchase order indicates that the item has been made especially for the job and is not subject to return or cancellation except by special negotiation.

Illustrations of Installations

Installation illustrations are intended to show the products and their options. Under no circumstances are they to be construed as recommended installation procedures. Consult local codes and project specifications for proper installation instructions.

General

Possession of this brochure or other sales literature is not to be construed as an offer to sell. All orders are subject to acceptance by the general office of Seller in Falconer, New York. Brochure printed in U.S.A.



ZURN INDUSTRIES, LLC FLO-THRU OPERATION, 1801 PITTSBURGH AVENUE, ERIE, PA, U.S.A. 16502
PHONE: 885-ONE-ZURN (855-663-9876) FAX: 814/875-1402 www.zurn.com

In Canada Call:

ZURN INDUSTRIES LIMITED 3544 NASHUA DRIVE, MISSISSAUGA, ONTARIO L4V 1L2
PHONE: 905/405-8272 FAX: 905/405-1292